

2022

# Lumi Stick

[www.neslight.com](http://www.neslight.com)

**NES** Light  
SMART SOLUTION

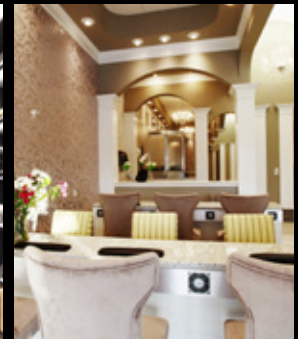



# Lumi Stick

custom led Linear is ideal for demanding retail, food service and utility applications such as consumer retail, restaurant menu boards, movie poster displays, jewelry stores, trade shows, office lobbies and conference, hanging from overhead





## CONTENTS

- P3. Contents Option Details
- P5. Showcase
- P12. Channel
- P18. Slim Surface & Suspension
- P32. Driver Built-in
- P41. Round
- P45. Architectural Surface & Suspension
- P61. Wall
- P68. Architectural Trimless
- P73. Architectural Recessed
- P80. Plaster in Trimless





## Showcase

						
<b>Model Number</b>	LS-T1	LS-T2	LS-T3	LS-S1	LS-S2	LS-S3
<b>Dimension(WxH)</b>	0.57" x 0.35"	0.5" x 0.5"	0.63" x 0.63"	0.47" x 0.25"	0.55" x 0.35"	0.65" x 0.37"
<b>Max. LED Power</b>	4.8W / ft	4.8W / ft	4.8W / ft	4.8W / ft	4.8W / ft	4.8W / ft
<b>Max. Length</b>	8' - 2"	8' - 2"	8' - 2"	8' - 2"	8' - 2"	8' - 2"
<b>Pages</b>	P. 6	P. 7	P. 8	P. 9	P. 10	P. 11



## Channel

					
<b>Model Number</b>	LS-C1	LS-C2	LS-C3	LS-C4	LS-C5
<b>Dimension(WxH)</b>	0.43" x 0.21"	0.63" x 0.23"	0.4" x 0.4"	0.47" x 0.47"	0.6" x 0.6"
<b>Max. LED Power</b>	4.8W / ft	4.8W / ft	4.8W / ft	4.8W / ft	4.8W / ft
<b>Max. Length</b>	8' - 2"	8' - 2"	8' - 2"	8' - 2"	8' - 2"
<b>Pages</b>	P. 13	P. 14	P. 15	P. 16	P. 17









## Slim Surface & Suspension

								
<b>Model Number</b>	LS-US20	LS-U20	LS-AT4	LS-AT5	LS-AT6	LS-AT11	LS-AT5H	LS-AT15-30
<b>Dimension(WxH)</b>	0.79" x 0.79"	0.79" x 1.57"	0.77" x 0.76"	0.77" x 0.76"	0.77" x 0.64"	0.77" x 0.49"	0.77" x 1.12"	0.98" x 1.17"
<b>Max. LED Power</b>	5.9W / ft	5.9W / ft	5.9W / ft	5.9W / ft	5.9W / ft	5.9W / ft	5.9W / ft	5.9W / ft
<b>Max. Length</b>	19' - 8"	19' - 8"	19' - 8"	19' - 8"	19' - 8"	19' - 8"	19' - 8"	19' - 8"
<b>Pages</b>	P. 19	P. 20	P. 21	P. 22	P. 23	P. 24	P. 25	P. 26



  

					
<b>Model Number</b>	LS-AT16-4	LS-AT16-5	LS-AT16-5H	LS-AT16-11	LS-AT16-30-60
<b>Dimension(WxH)</b>	0.77" x 1.02"	0.77" x 1.02"	0.77" x 1.4"	0.77" x 0.69"	0.77" x 0.69"
<b>Max. LED Power</b>	5.9W / ft	5.9W / ft	5.9W / ft	5.9W / ft	8.8W / ft
<b>Max. Length</b>	19' - 8"	19' - 8"	19' - 8"	19' - 8"	19' - 8"
<b>Pages</b>	P. 27	P. 28	P. 29	P. 30	P. 31















## Driver Built-in

								
<b>Model Number</b>	LS-P35	LS-PU35	LS-PUH35	LS-P46	LS-P50N	LS-P60	LS-EH80	LS-P74
<b>Dimension(WxH)</b>	1.38" x 2.68"	1.38" x 3.07"	1.38" x 3.47"	1.81" x 2.68"	1.97" x 2.95"	2.36" x 3.54"	3.15" x 3.94"	2.91" x 3.03"
<b>Max. LED Power</b>	11.7W / ft	11.7W / ft	11.7W / ft	11.7W / ft	11.7W / ft	11.7W / ft	11.7W / ft	11.7W / ft
<b>Max. Length</b>	19' - 8"	19' - 8"	19' - 8"	19' - 8"	19' - 8"	19' - 8"	19' - 8"	19' - 8"
<b>Pages</b>	P. 33	P. 34	P. 35	P. 36	P. 37	P. 38	P. 39	P. 40







## Round

			
<b>Model Number</b>	LS-R30	LS-R34	LS-R60
<b>Dimension(WxH)</b>	Φ1.18"	Φ1.34"	Φ2.36"
<b>Max. LED Power</b>	8.8W / ft	8.8W / ft	8.8W / ft
<b>Max. Length</b>	13' - 1"	16' - 4"	19' - 8"
<b>Pages</b>	P. 42	P. 43	P. 44





# Architectural Surface & Suspension

								
<b>Model Number</b>	LS-P24	LS-WN35	LS-WU35	LS-WUH35	LS-WN35-25	LS-WU35-25	LS-WUH35-25	LS-E50
<b>Dimension(WxH)</b>	0.98" x 4.72"	1.38" x 1.48"	1.38" x 1.87"	1.38" x 2.26"	1.38" x 1"	1.38" x 1.39"	1.38" x 1.79"	1.97" x 1.48"
<b>Max. LED Power</b>	11.7W / ft	11.7W / ft	11.7W / ft	11.7W / ft	11.7W / ft	11.7W / ft	11.7W / ft	11.7W / ft
<b>Max. Length</b>	13' - 1"	19' - 8"	19' - 8"	19' - 8"	19' - 8"	19' - 8"	19' - 8"	19' - 8"
<b>Pages</b>	P. 46	P. 47	P. 48	P. 49	P. 50	P. 51	P. 52	P. 53
								
<b>Model Number</b>	LS-EU50	LS-E60	LS-EU60	LS-E80	LS-EU80	LS-E100	LS-W91	
<b>Dimension(WxH)</b>	1.97" x 1.87"	2.36" x 1.48"	2.36" x 1.87"	3.15" x 1.48"	3.15" x 2.07"	4.02" x 1.22"	3.54" x 1.48"	
<b>Max. LED Power</b>	11.7W / ft	11.7W / ft	17.6W / ft	17.6W / ft	17.6W / ft	17.6W / ft	17.6W / ft	
<b>Max. Length</b>	13' - 1"	19' - 8"	19' - 8"	19' - 8"	19' - 8"	19' - 8"	19' - 8"	
<b>Pages</b>	P. 54	P. 55	P. 56	P. 57	P. 58	P. 59	P. 60	







# Wall

						
<b>Model Number</b>	LS-AW1	LS-AW2	LS-AW4-1	LS-AW8	LS-AW5-1	LS-AW35
<b>Dimension(WxH)</b>	1" x 2.76"	1.09" x 2.76"	0.93" x 3.27"	0.69" x 1.6"	1.38" x 3.27"	1.65" x 1.38"
<b>Max. LED Power</b>	5.9W / ft	4.4W / ft	4.4W / ft	5.9W / ft	5.9W / ft	11.7W / ft
<b>Max. Length</b>	19' - 8"	19' - 8"	19' - 8"	19' - 8"	19' - 8"	19' - 8"
<b>Pages</b>	P. 62	P. 63	P. 64	P. 65	P. 66	P. 67







# Architectural Trimless

				
<b>Model Number</b>	LS-TR35	LS-TR50	LS-TR60	LS-TR80
<b>Dimension(WxH)</b>	2.13" x 1.89"	2.64" x 1.89"	2.99" x 1.89"	3.78" x 1.89"
<b>Max. LED Power</b>	8.8W / ft	11.7W / ft	17.6W / ft	17.6W / ft
<b>Max. Length</b>	19' - 8"	19' - 8"	19' - 8"	19' - 8"
<b>Pages</b>	P. 69	P. 70	P. 71	P. 72

# Architectural Recessed







						
<b>Model Number</b>	LS-WN31	LS-ER50	LS-ER60	LS-ER50-2	LS-ER7635	LS-AW1-50
<b>Dimension(WxH)</b>	1.93" x 1.48"	2.52" x 1.77"	2.91" x 1.77"	3.15" x 0.98"	3.58" x 1.38"	0.77" x 1.97"
<b>Max. LED Power</b>	11.7W / ft	17.6W / ft	17.6W / ft	11.7W / ft	17.6W / ft	5.9W / ft
<b>Max. Length</b>	19' - 8"	16' - 4"	16' - 4"	19' - 8"	13' - 1"	19' - 8"
<b>Pages</b>	P. 74	P. 75	P. 76	P. 77	P. 78	P. 79

# Plaster in Trimless

							
<b>Model Number</b>	LS-CT4N	LS-CT5	LS-CT5S	LS-CT6	LS-CT7	LS-CT8	LS-AT7N
<b>Dimension(WxH)</b>	2.61" x 0.65"	2.32" x 0.54"	1.53" x 0.54"	1.96" x 1.03"	2.19" x 0.93"	1.67" x 1.22"	2.19" x 1.76"
<b>Max. LED Power</b>	5.9W / ft	5.9W / ft	5.9W / ft	5.9W / ft	5.9W / ft	5.9W / ft	5.9W / ft
<b>Max. Length</b>	8' - 2"	8' - 2"	8' - 2"	8' - 2"	8' - 2"	8' - 2"	19' - 8"
<b>Pages</b>	P. 81	P. 82	P. 83	P. 84	P. 85	P. 86	P. 87



## Showcase

						
<b>Model Number</b>	LS-T1	LS-T2	LS-T3	LS-S1	LS-S2	LS-S3
<b>Dimension(WxH)</b>	0.57" x 0.35"	0.5" x 0.5"	0.63" x 0.63"	0.47" x 0.25"	0.55" x 0.35"	0.65" x 0.37"
<b>Max. LED Power</b>	4.8W / ft	4.8W / ft	4.8W / ft	4.8W / ft	4.8W / ft	4.8W / ft
<b>Max. Length</b>	8' - 2"	8' - 2"	8' - 2"	8' - 2"	8' - 2"	8' - 2"
<b>Pages</b>	P. 6	P. 7	P. 8	P. 9	P. 10	P. 11

# LumiStick

## Showcase

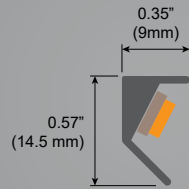

## LS-T1 Suitable for PCB 8mm

- Max. LED power : 4.8w/ft (15.8w/m)
- Installation : Surface
- Material : Extruded Aluminium 6063
- Finish : Silver anodised
- Diffuser : Non
- Length : 78.75"(2000mm) or 98.5"(2500mm) continuous
- Size : Profile w0.35"(9mm) x h0.57"(14.5mm)
- Driver installation : Remote driver required

Custom powder coated colour upon request. Surcharge apply.

Profile sold per metre.

Can be cut to suit any length up to 8' - 2"(2500mm).

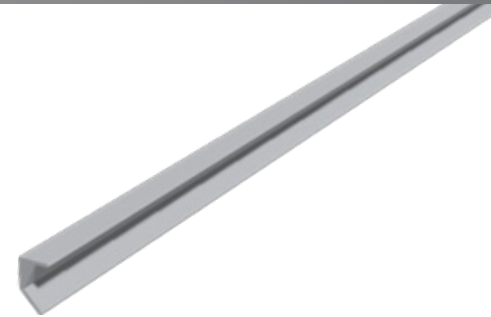

### Installing accessories



**Double face tape  
industrial grade**



# LumiStick

## Showcase

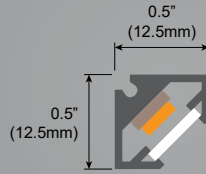

## LS-T2 Suitable for PCB 8mm

- Max. LED power : 4.8w/ft (15.8w/m)
- Installation : Surface
- Material : Extruded Aluminium 6063
- Finish : Silver anodised
- Diffuser : PMMA flexible diffuser
- Length : 78.75"(2000mm) or 98.5"(2500mm) continuous
- Size : Profile w0.5"(12.5mm) x h0.5"(12.5mm)
- Driver installation : Remote driver required

Custom powder coated colour upon request. Surcharge apply.

Profile sold per metre.

Can be cut to suit any length up to 8' - 2"(2500mm).



**PMMA Diffuser**  
CODE: LS-T2-F (FROST, LIGHT TRANS. >72%)



**PMMA Diffuser**  
CODE: LS-T2-C (CLEAR, LIGHT TRANS. >95%)

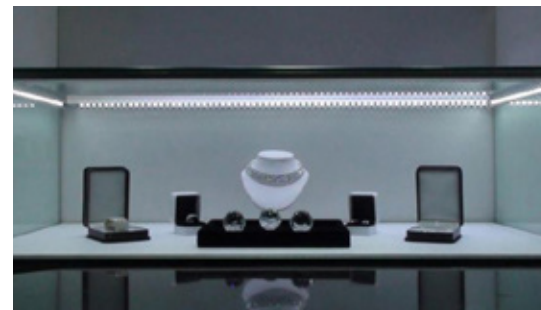

### Installing accessories



**Double face tape**  
industrial grade



**T2**  
Plastic Endcap  
CODE: T2-CAP  
CODE: T2-CAP-H



# LumiStick

Showcase

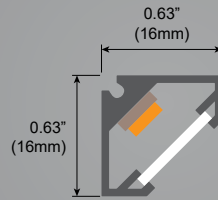

## LS-T3 Suitable for PCB 8mm

- Max. LED power : 4.8w/ft (15.8w/m)
- Installation : Surface
- Material : Extruded Aluminium 6063
- Finish : Silver anodised
- Diffuser : PMMA flexible diffuser
- Length : 78.75"(2000mm) or 98.5"(2500mm) continuous
- Size : Profile w0.63"(16mm) x h0.63"(16mm)
- Driver installation : Remote driver required

Custom powder coated colour upon request. Surcharge apply.

Profile sold per metre.

Can be cut to suit any length up to 8' - 2"(2500mm).

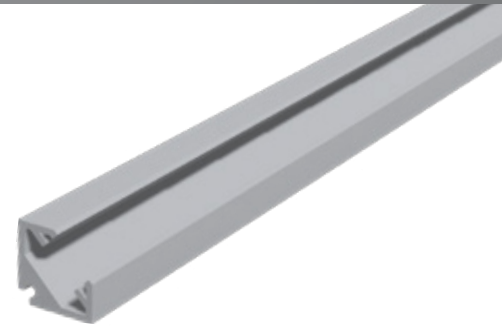

**PMMA Diffuser**  
CODE: LS-T3-F (FROST, LIGHT TRANS. >72%)



**PMMA Diffuser**  
CODE: LS-T3-C (CLEAR, LIGHT TRANS. >95%)



### Installing accessories



**Double face tape**  
**industrial grade**



**T3**  
**Plastic Endcap**  
CODE: T3-CAP  
CODE: T3-CAP-H





# LumiStick

## Showcase

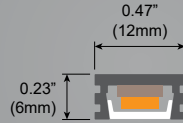

## LS-S1 Suitable for PCB 8mm

- Max. LED power : 4.8w/ft (15.8w/m)
- Installation : Surface / Recessed
- Material : Extruded Aluminium 6063
- Finish : Silver anodised
- Diffuser : PMMA flexible diffuser
- Length : 78.75"(2000mm) or 98.5"(2500mm) continuous
- Size : Profile w0.47"(12mm) x h0.23"(6mm)
- Driver installation : Remote driver required

Custom powder coated colour upon request. Surcharge apply.

Profile sold per metre.

Can be cut to suit any length up to 8' - 2"(2500mm).



### PMMA Diffuser

CODE: LS-S1-F (FROST, LIGHT TRANS. >72%)



## Installing accessories



**Double face tape**  
industrial grade



**S1**  
Plastic Endcap  
CODE: S1-CAP  
CODE: S1-CAP-H



**Metal Clip**  
CODE: S1-CLIP-M



**Suspension Kits**  
CODE: SUS.KITSA



# LumiStick

Showcase

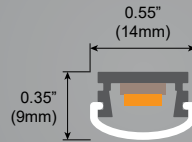

## LS-S2 Suitable for PCB 8mm

- Max. LED power : 4.8w/ft (15.8w/m)
- Installation : Surface / Suspended
- Material : Extruded Aluminium 6063
- Finish : Silver anodised
- Diffuser : PMMA flexible diffuser
- Length : 78.75"(2000mm) or 98.5"(2500mm) continuous
- Size : Profile w0.55"(14mm) x h0.35"(9mm)
- Driver installation : Remote driver required

Custom powder coated colour upon request. Surcharge apply.

Profile sold per metre.

Can be cut to suit any length up to 8' - 2"(2500mm).





**PMMA Diffuser**  
CODE: LS-S2-F (FROST, LIGHT TRANS. >72%)



**PMMA Diffuser**  
CODE: LS-S2-C (CLEAR, LIGHT TRANS. >95%)

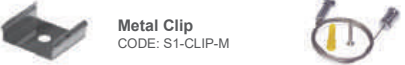

### Installing accessories

 <p><b>Double face tape</b> industrial grade</p>	
 <p><b>S2 Plastic Endcap</b> CODE: S2-CAP CODE: S2-CAP-H</p>	
 <p><b>Metal Clip</b> CODE: S1-CLIP-M</p> <p><b>Suspension Kits</b> CODE: SUS.KITSA</p>	

# LumiStick

## Showcase

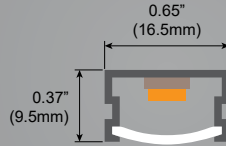

## LS-S3 Suitable for PCB 14mm

- Max. LED power : 4.8w/ft (15.8w/m)
- Installation : Surface / Suspended / Recessed
- Material : Extruded Aluminium 6063
- Finish : Silver anodised
- Diffuser : PMMA flexible diffuser
- Length : 78.75"(2000mm) or 98.5"(2500mm) continuous
- Size : Profile w0.65"(16.5mm) x h0.37"(9.5mm)
- Driver installation : Remote driver required

Custom powder coated colour upon request. Surcharge apply.

Profile sold per metre.

Can be cut to suit any length up to 8' - 2"(2500mm).



**PMMA Diffuser**  
CODE : LS-S3-F (FROST, LIGHT TRANS. >72%)

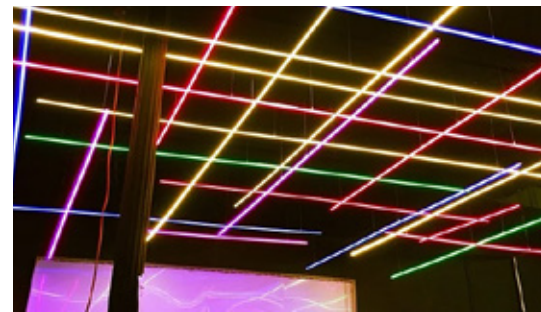

### Installing accessories



**Double face tape**  
industrial grade



**S2**  
Plastic Endcap  
CODE: S3-CAP  
CODE: S3-CAP-H



**Metal Clip**  
CODE: S3-CLIP-M







**Suspension Kits**  
CODE : SUS.KITSA





## Channel

					
<b>Model Number</b>	LS-C1	LS-C2	LS-C3	LS-C4	LS-C5
<b>Dimension(WxH)</b>	0.43" x 0.21"	0.63" x 0.23"	0.4" x 0.4"	0.47" x 0.47"	0.6" x 0.6"
<b>Max. LED Power</b>	4.8W / ft	4.8W / ft	4.8W / ft	4.8W / ft	4.8W / ft
<b>Max. Length</b>	8' - 2"	8' - 2"	8' - 2"	8' - 2"	8' - 2"
<b>Pages</b>	P. 13	P. 14	P. 15	P. 16	P. 17

# LumiStick

Channel

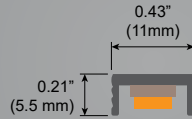

## LS-C1 Suitable for PCB 8mm

- Max. LED power : 4.8w/ft (15.8w/m)
- Installation : Surface / Recessed
- Material : Extruded Aluminium 6063
- Finish : Silver anodised
- Diffuser : Non
- Length : 78.75"(2000mm) or 98.5"(2500mm) continuous
- Size : Profile w0.43"(11mm) x h0.21"(5.5mm)
- Driver installation : Remote driver required

Custom powder coated colour upon request. Surcharge apply.

Profile sold per metre.

Can be cut to suit any length up to 8' - 2"(2500mm).

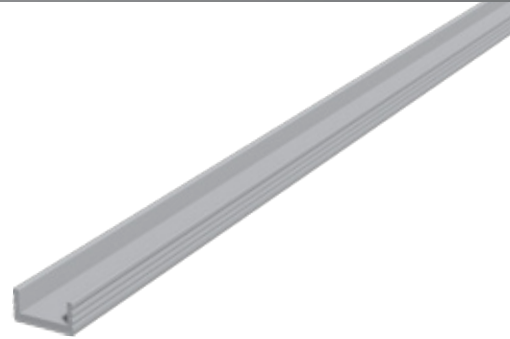

### Installing accessories



**Double face tape  
industrial grade**



# LumiStick

Channel

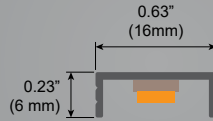

## LS-C2 Suitable for PCB 13mm

- Max. LED power : 4.8w/ft (15.8w/m)
- Installation : Surface / Recessed
- Material : Extruded Aluminium 6063
- Finish : Silver anodised
- Diffuser : Non
- Length : 78.75"(2000mm) or 98.5"(2500mm) continuous
- Size : Profile w0.63"(16mm) x h0.23"(6mm)
- Driver installation : Remote driver required

Custom powder coated colour upon request. Surcharge apply.

Profile sold per metre.

Can be cut to suit any length up to 8' - 2"(2500mm).



### Installing accessories



**Double face tape  
industrial grade**

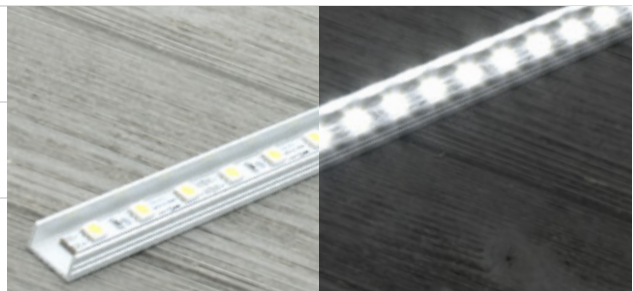

# LumiStick

Channel

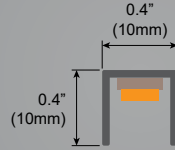

## LS-C3 Suitable for PCB 8mm

- Max. LED power : 4.8w/ft (15.8w/m)
- Installation : Surface / Recessed
- Material : Extruded Aluminium 6063
- Finish : Silver anodised
- Diffuser : Non
- Length : 78.75"(2000mm) or 98.5"(2500mm) continuous
- Size : Profile w0.4"(10mm) x h0.4"(10mm)
- Driver installation : Remote driver required

Custom powder coated colour upon request. Surcharge apply.

Profile sold per metre.

Can be cut to suit any length up to 8' - 2"(2500mm).

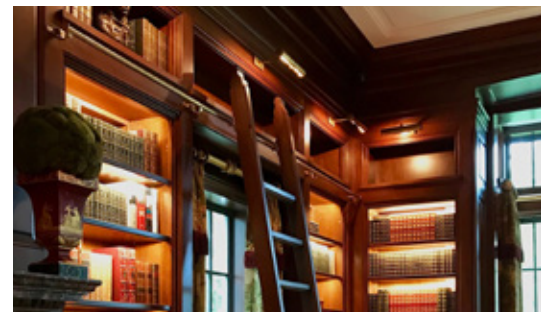
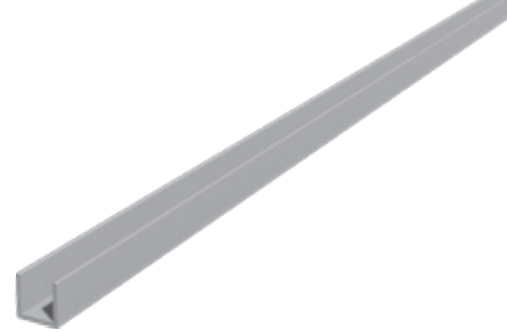

### Installing accessories



**Double face tape  
industrial grade**

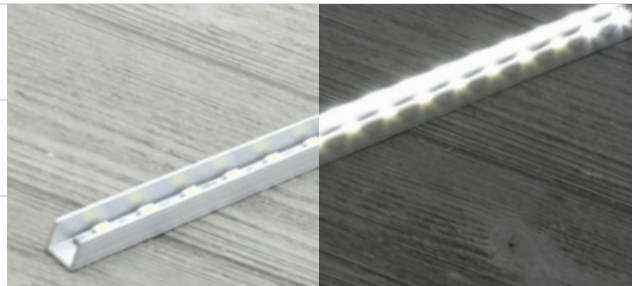

# LumiStick

Channel

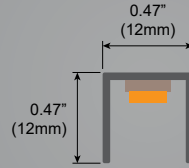

## LS-C4 Suitable for PCB 8mm

- Max. LED power : 4.8w/ft (15.8w/m)
- Installation : Surface / Recessed
- Material : Extruded Aluminium 6063
- Finish : Silver anodised
- Diffuser : Non
- Length : 78.75"(2000mm) or 98.5"(2500mm) continuous
- Size : Profile w0.47"(12mm) x h0.47"(12mm)
- Driver installation : Remote driver required

Custom powder coated colour upon request. Surcharge apply.

Profile sold per metre.

Can be cut to suit any length up to 8' - 2"(2500mm).

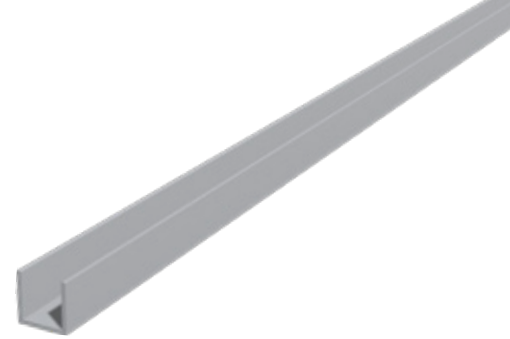

### Installing accessories



**Double face tape  
industrial grade**

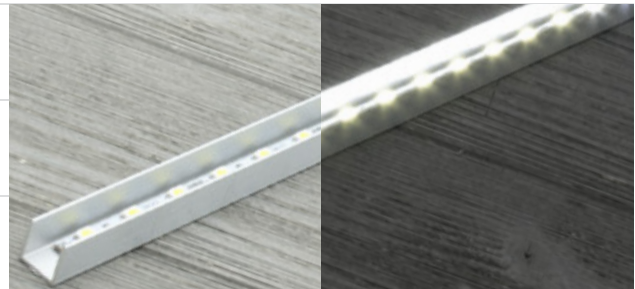



# LumiStick

Channel

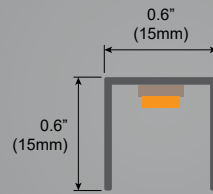

## LS-C5 Suitable for PCB 12mm

- Max. LED power : 4.8w/ft (15.8w/m)
- Installation : Surface / Recessed
- Material : Extruded Aluminium 6063
- Finish : Silver anodised
- Diffuser : Non
- Length : 78.75"(2000mm) or 98.5"(2500mm) continuous
- Size : Profile w0.6"(15mm) x h0.6"(15mm)
- Driver installation : Remote driver required

Custom powder coated colour upon request. Surcharge apply.

Profile sold per metre.

Can be cut to suit any length up to 8' - 2"(2500mm).

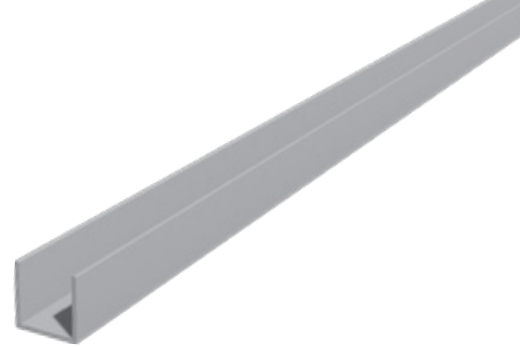

### Installing accessories





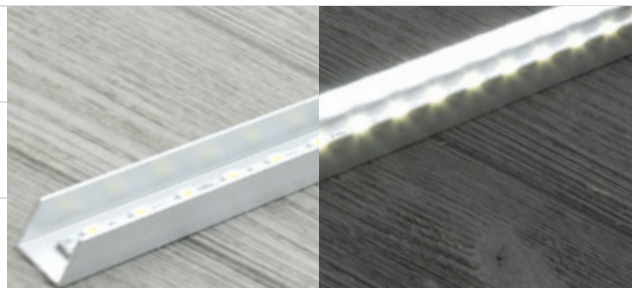









**Double face tape  
industrial grade**





## Slim Surface & Suspension

								
<b>Model Number</b>	LS-US20	LS-U20	LS-AT4	LS-AT5	LS-AT6	LS-AT11	LS-AT5H	LS-AT15-30
<b>Dimension(WxH)</b>	0.79" x 0.79"	0.79" x 1.57"	0.77" x 0.76"	0.77" x 0.76"	0.77" x 0.64"	0.77" x 0.49"	0.77" x 1.12"	0.98" x 1.17"
<b>Max. LED Power</b>	5.9W / ft	5.9W / ft	5.9W / ft	5.9W / ft	5.9W / ft	5.9W / ft	5.9W / ft	5.9W / ft
<b>Max. Length</b>	19' - 8"	19' - 8"	19' - 8"	19' - 8"	19' - 8"	19' - 8"	19' - 8"	19' - 8"
<b>Pages</b>	P. 19	P. 20	P. 21	P. 22	P. 23	P. 24	P. 25	P. 26
								
<b>Model Number</b>	LS-AT16-4	LS-AT16-5	LS-AT16-5H	LS-AT16-11	LS-AT16-30-60			
<b>Dimension(WxH)</b>	0.77" x 1.02"	0.77" x 1.02"	0.77" x 1.4"	0.77" x 0.69"	0.77" x 0.69"			
<b>Max. LED Power</b>	5.9W / ft	5.9W / ft	5.9W / ft	5.9W / ft	8.8W / ft			
<b>Max. Length</b>	19' - 8"	19' - 8"	19' - 8"	19' - 8"	19' - 8"			
<b>Pages</b>	P. 27	P. 28	P. 29	P. 30	P. 31			

# LumiStick

Slim Surface & Suspension

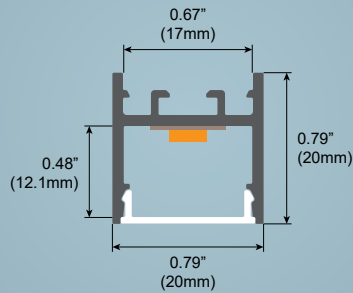

## LS-US20 Suitable for PCB 15mm

- Max. LED power : 5.9w/ft (19.2w/m)
- Installation : Surface / Suspended
- Material : Extruded Aluminium 6063
- Finish : Silver anodised, Black, White
- Diffuser : PMMA flexible diffuser, can be 82'(25m) continuous rolled
- Length : 78.75"(2000mm) or 98.5"(2500mm) continuous
- Size : Profile w0.79"(20mm) x h0.79"(20mm)
- Driver installation : Remote driver required

Custom powder coated colour upon request. Surcharge apply.

Profile sold per metre.

Can be cut to suit any length up to 19' - 8"(6000mm).

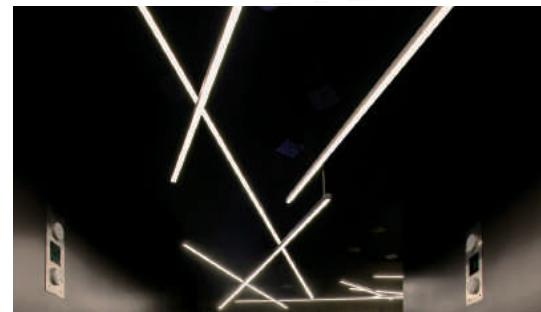
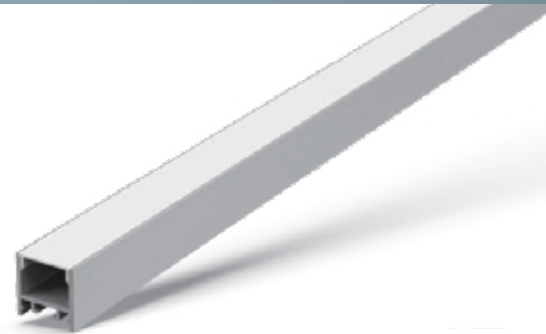

**PMMA Diffuser**  
CODE : US20-O (OPAL, LIGHT TRANS. >55%)



**Black Diffuser**  
CODE : US20-B (BLACK, LIGHT TRANS. > 22%)  
MOQ : 200M

### Installing accessories



**LS-US20 Plastic Endcap**  
CODE : US20-CAP  
CODE : US20-CAP-H



**Metal Clip**  
CODE : US20-CLIP-M



**Joiners 90°A**  
CODE: J-90A



**Joiners 90°B**  
CODE: J-90B



**Suspension Kits**  
CODE : SUS.KITSA



**Joiners 120°A**  
CODE: J-120A



**Joiners 120°B**  
CODE: J-120B



**Aluminium Diffuser**  
CODE-US20-AD



**Joiners 180°A**  
CODE: J-180A

# Lumi Stick

Slim Surface & Suspension

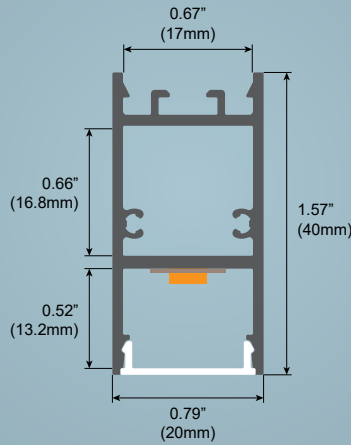

## LS-U20 Suitable for PCB 15mm

- Max. LED power : 5.9w/ft (19.2w/m)
- Installation : Surface / Suspended
- Material : Extruded Aluminium 6063
- Finish : Silver anodised, Black, White
- Diffuser : PMMA flexible diffuser, can be 82'(25m) continuous rolled
- Length : 78.75"(2000mm) or 98.5"(2500mm) continuous
- Size : Profile w0.79"(20mm) x h1.57"(40mm)
- Driver installation : Remote driver required

Custom powder coated colour upon request. Surcharge apply.

Profile sold per metre.

Can be cut to suit any length up to 19' - 8"(6000mm).

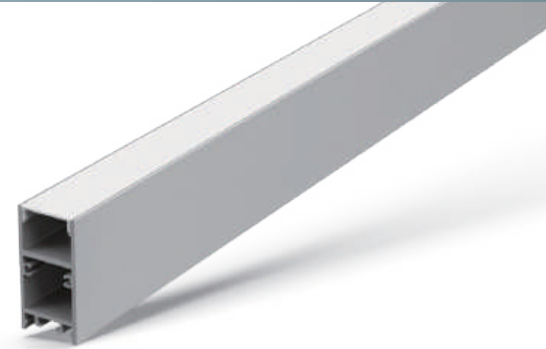











**PMMA Diffuser**  
CODE : US20-O (OPAL, LIGHT TRANS. >55%)

**Black Diffuser**  
CODE : US20-B (BLACK, LIGHT TRANS. > 22%)  
MOQ : 200M



### Installing accessories

	<b>LS-U20 CNC Aluminium Cap</b> CODE: U20-CAP		<b>Metal Clip</b> CODE: U20-CLIP-M		<b>Joiners 90°A</b> CODE: J-90A		<b>Joiners 90°B</b> CODE: J-90B
	<b>LS-U20 Aluminium Endcap</b> CODE: U20-CAP		<b>Suspension Kits</b> CODE: SUS.KITSA		<b>Joiners 120°A</b> CODE: J-120A		<b>Joiners 120°B</b> CODE: J-120B
	<b>Aluminium Diffuser</b> CODE-US20-AD		<b>Joiners 180°A</b> CODE: J-180A				

# Lumi Stick

Slim Surface & Suspension

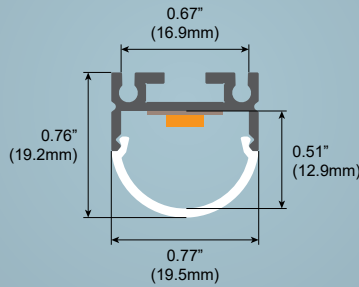

## LS-AT4 Suitable for PCB 15mm

- Max. LED power : 5.9w/ft (19.2w/m)
- Installation : Surface / Suspended
- Material : Extruded Aluminium 6063
- Finish : Silver anodised, Black, White
- Diffuser : PMMA flexible diffuser, can be 82'(25m) continuous rolled
- Length : 78.75"(2000mm) or 98.5"(2500mm) continuous
- Size : Profile w0.77"(19.5mm) x h0.76"(19.2mm)
- Driver installation : Remote driver required

Custom powder coated colour upon request. Surcharge apply.

Profile sold per metre.

Can be cut to suit any length up to 19' - 8"(6000mm).



**PMMA Diffuser**  
 CODE: AT4-O (OPAL, LIGHT TRANS. >52%)  
 CODE: AT4-F (FROST, LIGHT TRANS. >72%)

### Installing accessories

	<b>AT4 Plastic Endcap</b> CODE: AT4-CAP CODE: AT4-CAP-H		<b>Metal Clip</b> CODE: AT11-CLIP-M		<b>Joiners 90°A</b> CODE: J-90A		<b>Joiners 90°B</b> CODE: J-90B
	<b>Suspension Kits</b> CODE: SUS.KITSA		<b>Joiners 120°A</b> CODE: J-120A		<b>Joiners 120°B</b> CODE: J-120B		
	<b>*0-222° rotation Adjustable Clip</b> CODE: AT11-CLIP-A		<b>Joiners 180°A</b> CODE: J-180A				

# Lumi Stick

Slim Surface & Suspension

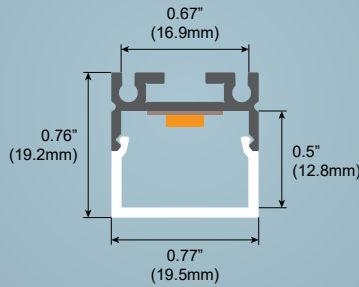

## LS-AT5 Suitable for PCB 15mm

- Max. LED power : 5.9w/ft (19.2w/m)
- Installation : Surface / Suspended
- Material : Extruded Aluminium 6063
- Finish : Silver anodised, Black, White
- Diffuser : PMMA flexible diffuser, can be 82'(25m) continuous rolled
- Length : 78.75"(2000mm) or 98.5"(2500mm) continuous
- Size : Profile w0.77"(19.5mm) x h0.76"(19.2mm)
- Driver installation : Remote driver required

Custom powder coated colour upon request. Surcharge apply.

Profile sold per metre.

Can be cut to suit any length up to 19' - 8"(6000mm).



**PMMA Diffuser**  
CODE: AT5-O (OPAL, LIGHT TRANS. >52%)  
CODE: AT5-F (FROST, LIGHT TRANS. >72%)



**Black Diffuser**  
CODE: AT5-B (BLACK, LIGHT TRANS. >22%)  
MOQ : 200M

### Installing accessories



**AT5 Plastic Endcap**  
CODE: AT5-CAP  
CODE: AT5-CAP-H



**Metal Clip**  
CODE: AT11-CLIP-M



**Joiners 90°A**  
CODE: J-90A



**Joiners 90°B**  
CODE: J-90B



**Suspension Kits**  
CODE: SUS.KITSA



**Joiners 120°A**  
CODE: J-120A



**Joiners 120°B**  
CODE: J-120B



**\*0-222° rotation Adjustable Clip**  
CODE: AT11-CLIP-A



**Joiners 180°A**  
CODE: J-180A

# Lumi Stick

Slim Surface & Suspension

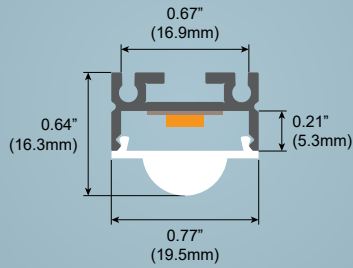

## LS-AT6 Suitable for PCB 15mm

- Max. LED power : 5.9w/ft (19.2w/m)
- Installation : Surface / Suspended
- Material : Extruded Aluminium 6063
- Finish : Silver anodised, Black, White
- Diffuser : PMMA flexible diffuser, can be 82'(25m) continuous rolled
- Length : 78.75"(2000mm) or 98.5"(2500mm) continuous
- Size : Profile w0.77"(19.5mm) x h0.64"(16.3mm)
- Driver installation : Remote driver required

Custom powder coated colour upon request. Surcharge apply.

Profile sold per metre.

Can be cut to suit any length up to 19' - 8"(6000mm).



**PMMA Diffuser**  
CODE: AT6-C (CLEAR, LIGHT TRANS. >95%)

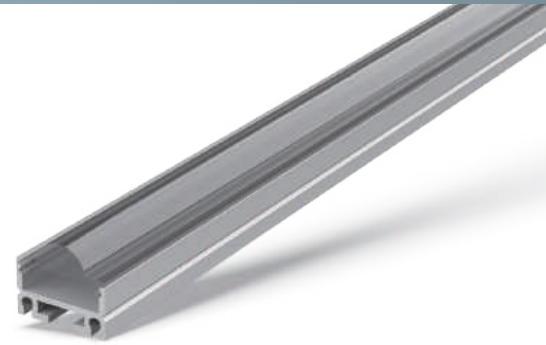

### Installing accessories

	<b>AT6 Plastic Endcap</b> CODE: AT6-CAP CODE: AT6-CAP-H		<b>Metal Clip</b> CODE: AT11-CLIP-M		<b>Joiners 90°A</b> CODE: J-90A		<b>Joiners 90°B</b> CODE: J-90B
	<b>Suspension Kits</b> CODE: SUS.KITSA		<b>Joiners 120°A</b> CODE: J-120A		<b>Joiners 120°B</b> CODE: J-120B		
	<b>*0-222° rotation Adjustable Clip</b> CODE: AT11-CLIP-A		<b>Joiners 180°A</b> CODE: J-180A				

# Lumi Stick

Slim Surface & Suspension

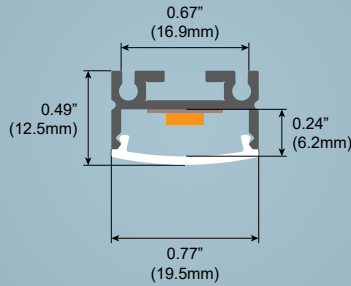

## LS-AT11 Suitable for PCB 15mm

- Max. LED power : 5.9w/ft (19.2w/m)
- Installation : Surface / Suspended
- Material : Extruded Aluminium 6063
- Finish : Silver anodised, Black, White
- Diffuser : PMMA flexible diffuser, can be 82'(25m) continuous rolled
- Length : 78.75"(2000mm) or 98.5"(2500mm) continuous
- Size : Profile w0.77"(19.5mm) x h0.49"(12.5mm)
- Driver installation : Remote driver required

Custom powder coated colour upon request. Surcharge apply.

Profile sold per metre.



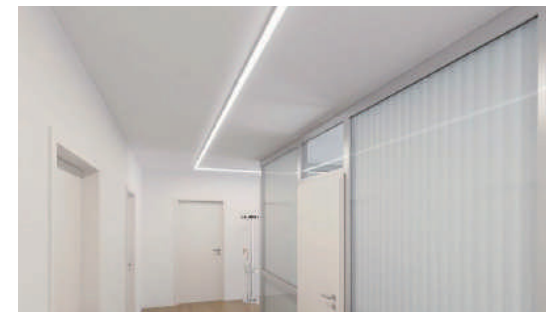





Can be cut to suit any length up to 19' - 8"(6000mm).



### PMMA Diffuser

CODE: AT11-O (OPAL, LIGHT TRANS. >68%)  
CODE: AT11-F (FROST, LIGHT TRANS. >83%)

### Installing accessories

	<b>AT11 Aluminium Endcap</b> CODE: AT11-CAP CODE: AT11-CAP-H		<b>Metal Clip</b> CODE: AT11-CLIP-M		<b>Joiners 90°A</b> CODE: J-90A		<b>Joiners 90°B</b> CODE: J-90B
	<b>Suspension Kits</b> CODE: SUS.KITSA		<b>Joiners 120°A</b> CODE: J-120A		<b>Joiners 120°B</b> CODE: J-120B		
	<b>*0-222° rotation Adjustable Clip</b> CODE: AT11-CLIP-A		<b>Joiners 180°A</b> CODE: J-180A				



# Lumi Stick

Slim Surface & Suspension

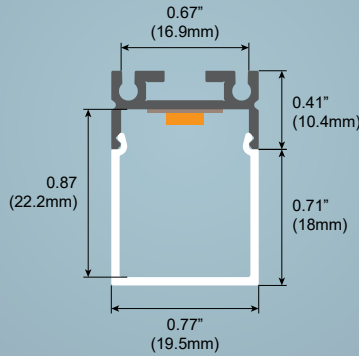

## LS-AT5H Suitable for PCB 15mm

- Max. LED power : 5.9w/ft (19.2w/m)
- Installation : Surface / Suspended
- Material : Extruded Aluminium 6063
- Finish : Silver anodised, Black, White
- Diffuser : PMMA flexible diffuser, can be 82'(25m) continuous rolled
- Length : 78.75"(2000mm) or 98.5"(2500mm) continuous
- Size : Profile w0.77"(19.5mm) x h0.87"(22.2mm)
- Driver installation : Remote driver required

Custom powder coated colour upon request. Surcharge apply.





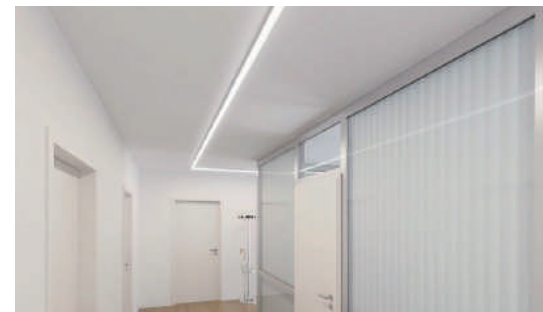
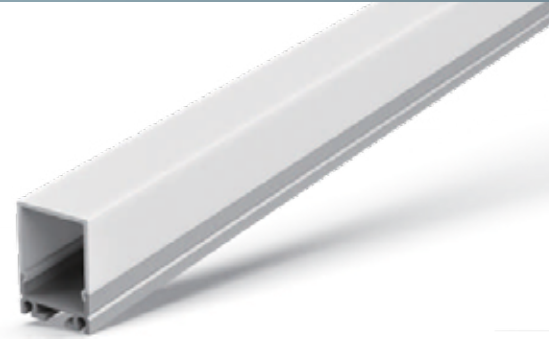



Profile sold per metre.

Can be cut to suit any length up to 19' - 8"(6000mm).



**PMMA Diffuser**  
CODE: AT5H-O (OPAL, LIGHT TRANS. >52%)

### Installing accessories

 <p><b>AT5H Aluminium Endcap</b> CODE: AT5H-CAP CODE: AT5H-CAP-H</p>	 <p><b>Metal Clip</b> CODE: AT11-CLIP-M</p>	 <p><b>Joiners 90°A</b> CODE: J-90A</p>	 <p><b>Joiners 90°B</b> CODE: J-90B</p>
 <p><b>Suspension Kits</b> CODE: SUS.KITSA</p>	 <p><b>Joiners 120°A</b> CODE: J-120A</p>	 <p><b>Joiners 120°B</b> CODE: J-120B</p>	
 <p><b>*0-222° rotation Adjustable Clip</b> CODE: AT11-CLIP-A</p>	 <p><b>Joiners 180°A</b> CODE: J-180A</p>		

# LumiStick

Slim Surface & Suspension

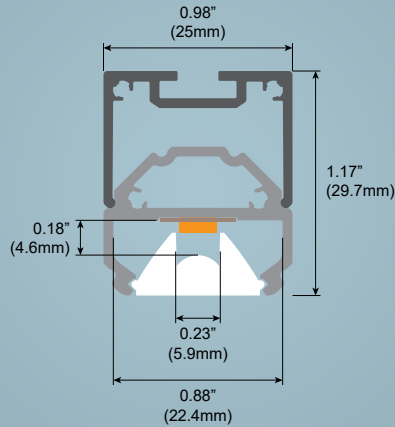

## LS-AT15-30 Suitable for PCB 10mm

- Max. LED power : 5.9w/ft (19.2w/m)
- Installation : Surface / Suspended
- Material : Extruded Aluminium 6063
- Finish : Silver anodised, Black, White
- Diffuser : PMMA flexible diffuser, can be 82'(25m) continuous rolled
- Length : 78.75"(2000mm) or 98.5"(2500mm) continuous
- Size : Profile w0.98"(25mm) x h1.17"(29.7mm)
- Driver installation : Remote driver required

Custom powder coated colour upon request. Surcharge apply.

Profile sold per metre.

Can be cut to suit any length up to 19' - 8"(6000mm).



**PMMA Diffuser**  
CODE: AT15-30-C (CLEAR, LIGHT TRANS. >95%)

### Installing accessories



**LS-AT15-30**  
**Aluminium Endcap**  
CODE: AT15-30-CAP  
CODE: AT15-30-CAP-H



**Suspension Kits**  
CODE : SUS.KITSA



**Joiners 90°A**  
CODE: J-90A



**Joiners 90°B**  
CODE: J-90B



**Joiners 120°A**  
CODE: J-120A



**Joiners 120°B**  
CODE: J-120B



**Joiners 180°A**  
CODE: J-180A

# LumiStick

Slim Surface & Suspension

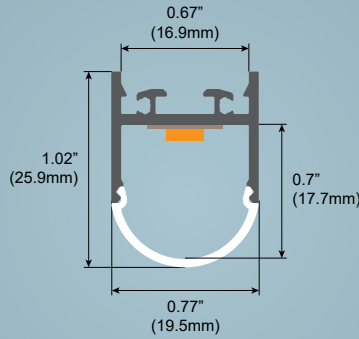

## LS-AT16-4 Suitable for PCB 15mm

- Max. LED power : 5.9w/ft (19.2w/m)
- Installation : Surface / Suspended
- Material : Extruded Aluminium 6063
- Finish : Silver anodised, Black, White
- Diffuser : PMMA flexible diffuser, can be 82'(25m) continuous rolled
- Length : 78.75'(2000mm) or 98.5'(2500mm) continuous
- Size : Profile w0.77"(19.5mm) x h1.02"(25.9mm)
- Driver installation : Remote driver required

Custom powder coated colour upon request. Surcharge apply.

Profile sold per metre.

Can be cut to suit any length up to 19' - 8"(6000mm).



### PMMA Diffuser

CODE: AT16-4-O (OPAL, LIGHT TRANS. >52%)  
CODE: AT16-4-F (FROST, LIGHT TRANS. >72%)

### Installing accessories

	<b>LS-AT16-4 Aluminum Cap</b> CODE: AT16-4-CAP-R CODE: AT16-4-CAP-L		<b>Metal Clip</b> CODE: U20-CLIP-M		<b>Joiners 90°A</b> CODE: J-90A		<b>Joiners 90°B</b> CODE: J-90B
	<b>Suspension Kits</b> CODE: SUS.KITSA		<b>Joiners 120°A</b> CODE: J-120A		<b>Joiners 120°B</b> CODE: J-120B		
	<b>Aluminium Diffuser</b> CODE-US20-AD		<b>Joiners 180°A</b> CODE: J-180A				

# LumiStick

Slim Surface & Suspension

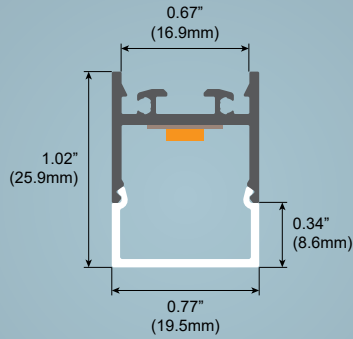

## LS-AT16-5 Suitable for PCB 15mm

- Max. LED power : 5.9w/ft (19.2w/m)
- Installation : Surface / Suspended
- Material : Extruded Aluminium 6063
- Finish : Silver anodised, Black, White
- Diffuser : PMMA flexible diffuser, can be 82'(25m) continuous rolled
- Length : 78.75'(2000mm) or 98.5'(2500mm) continuous
- Size : Profile w0.77"(19.5mm) x h1.02"(25.9mm)
- Driver installation : Remote driver required

Custom powder coated colour upon request. Surcharge apply.

Profile sold per metre.

Can be cut to suit any length up to 19' - 8"(6000mm).

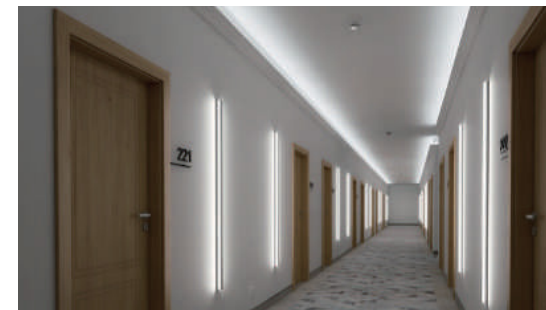
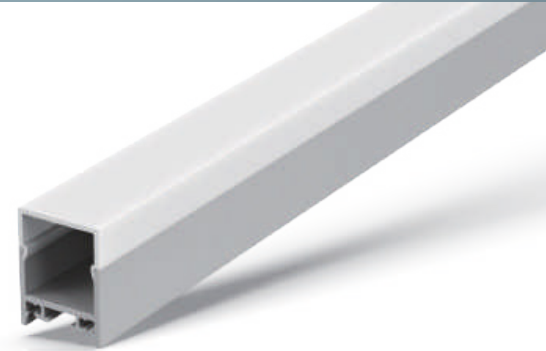

### PMMA Diffuser

CODE: AT16-5-O (OPAL, LIGHT TRANS. >52%)  
CODE: AT16-5-F (FROST, LIGHT TRANS. >72%)

### Installing accessories

	<b>LS-AT16-5 Aluminum Cap</b> CODE: AT16-5-CAP CODE: AT16-5-CAP-H		<b>Metal Clip</b> CODE: U20-CLIP-M		<b>Joiners 90°A</b> CODE: J-90A		<b>Joiners 90°B</b> CODE: J-90B
	<b>Suspension Kits</b> CODE: SUS.KITSA		<b>Joiners 120°A</b> CODE: J-120A		<b>Joiners 120°B</b> CODE: J-120B		
	<b>Aluminium Diffuser</b> CODE-US20-AD		<b>Joiners 180°A</b> CODE: J-180A				

# LumiStick

Slim Surface & Suspension

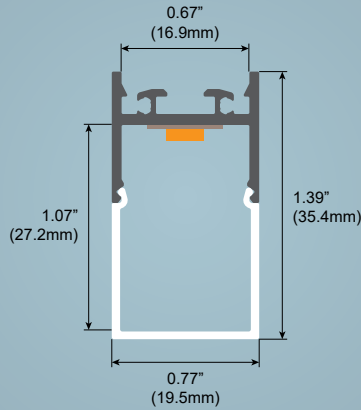

## LS-AT16-5H Suitable for PCB 15mm

- Max. LED power : 5.9w/ft (19.2w/m)
- Installation : Surface / Suspended
- Material : Extruded Aluminium 6063
- Finish : Silver anodised, Black, White
- Diffuser : PMMA flexible diffuser, can be 82'(25m) continuous rolled
- Length : 78.75'(2000mm) or 98.5'(2500mm) continuous
- Size : Profile w0.77"(19.5mm) x h1.39"(35.4mm)
- Driver installation : Remote driver required

Custom powder coated colour upon request. Surcharge apply.

Profile sold per metre.

Can be cut to suit any length up to 19' - 8"(6000mm).



**PMMA Diffuser**  
CODE: AT16-5H-O (OPAL, LIGHT TRANS. >52%)

### Installing accessories

	<b>LS-AT16-5H Aluminium Endcap</b> CODE: AT16-5-CAP CODE: AT16-5-CAP-H		<b>Metal Clip</b> CODE: U20-CLIP-M		<b>Joiners 90°A</b> CODE: J-90A		<b>Joiners 90°B</b> CODE: J-90B
	<b>Suspension Kits</b> CODE: SUS.KITSA		<b>Joiners 120°A</b> CODE: J-120A		<b>Joiners 120°B</b> CODE: J-120B		
	<b>Aluminium Diffuser</b> CODE-US20-AD		<b>Joiners 180°A</b> CODE: J-180A				

# LumiStick

Slim Surface & Suspension

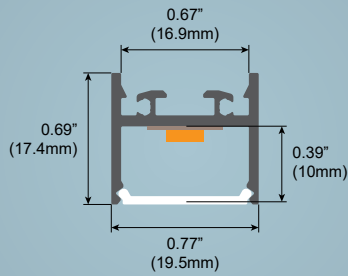

## LS-AT16-11 Suitable for PCB 15mm

- Max. LED power : 5.9w/ft (19.2w/m)
- Installation : Surface / Suspended
- Material : Extruded Aluminium 6063
- Finish : Silver anodised, Black, White
- Diffuser : PMMA flexible diffuser, can be 82'(25m) continuous rolled
- Length : 78.75"(2000mm) or 98.5"(2500mm) continuous, lens in 350mm
- Size : Profile w0.77"(19.5mm) x h0.69"(17.4mm)
- Driver installation : Remote driver required

Custom powder coated colour upon request. Surcharge apply.

Profile sold per metre.

Can be cut to suit any length up to 19' - 8"(6000mm).







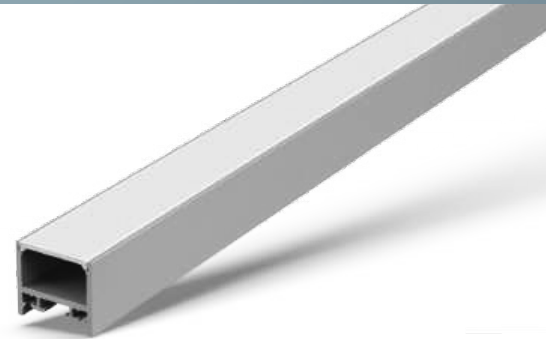



### PMMA Diffuser

CODE: AT16-11-O (OPAL, LIGHT TRANS. >52%)  
CODE: AT16-11-F (FROST, LIGHT TRANS. >81%)



### Installing accessories

	<b>AT16-11 Aluminum Cap</b> CODE: AT16-11-CAP CODE: AT16-11-CAP-H		<b>Metal Clip</b> CODE: US20-CLIP-M		<b>Joiners 90°A</b> CODE: J-90A		<b>Joiners 90°B</b> CODE: J-90B
	<b>Suspension Kits</b> CODE: SUS.KITSA		<b>Joiners 120°A</b> CODE: J-120A		<b>Joiners 120°B</b> CODE: J-120B		
			<b>Joiners 180°A</b> CODE: J-180A				

# LumiStick

Slim Surface & Suspension

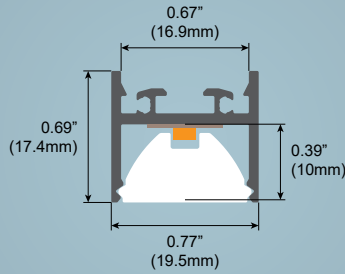

## LS-AT16-30-60 Suitable for PCB 15mm

- Max. LED power : 5.9w/ft (19.2w/m)
- Installation : Surface / Suspended
- Material : Extruded Aluminium 6063
- Finish : Silver anodised, Black, White
- Diffuser : PMMA flexible diffuser, can be 82"(25m) continuous rolled
- Length : 78.75"(2000mm) or 98.5"(2500mm) continuous, lens in 350mm
- Size : Profile w0.77"(19.5mm) x h0.69"(17.4mm)
- Driver installation : Remote driver required

Custom powder coated colour upon request. Surcharge apply.

Profile sold per metre.







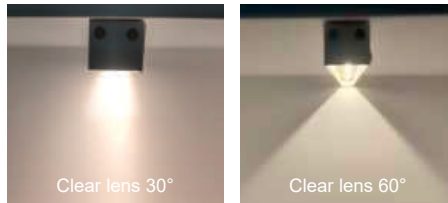

Can be cut to suit any length up to 19' - 8"(6000mm).



**PMMA Diffuser**  
CODE: AT16-30-60-C (CLEAR, LIGHT TRANS. >95%)











### Installing accessories

 <p><b>AT16-30-60 Aluminium Endcap</b> CODE: AT16-30-60-CAP CODE: AT16-30-60-CAP-H</p>	 <p><b>Metal Clip</b> CODE: US20-CLIP-M</p>	 <p><b>Joiners 90°A</b> CODE: J-90A</p>	 <p><b>Joiners 90°B</b> CODE: J-90B</p>
 <p><b>Suspension Kits</b> CODE: SUS.KITSA</p>	 <p><b>Joiners 120°A</b> CODE: J-120A</p>	 <p><b>Joiners 120°B</b> CODE: J-120B</p>	
	 <p><b>Joiners 180°A</b> CODE: J-180A</p>		



## Driver Built-in

								
<b>Model Number</b>	LS-P35	LS-PU35	LS-PUH35	LS-P46	LS-P50N	LS-P60	LS-EH80	LS-P74
<b>Dimension(WxH)</b>	1.38" x 2.68"	1.38" x 3.07"	1.38" x 3.47"	1.81" x 2.68"	1.97" x 2.95"	2.36" x 3.54"	3.15" x 3.94"	2.91" x 3.03"
<b>Max. LED Power</b>	11.7W / ft	11.7W / ft	11.7W / ft	11.7W / ft	11.7W / ft	11.7W / ft	11.7W / ft	11.7W / ft
<b>Max. Length</b>	19' - 8"	19' - 8"	19' - 8"	19' - 8"	19' - 8"	19' - 8"	19' - 8"	19' - 8"
<b>Pages</b>	P. 33	P. 34	P. 35	P. 36	P. 37	P. 38	P. 39	P. 40



# Lumi Stick

Driver Built-in

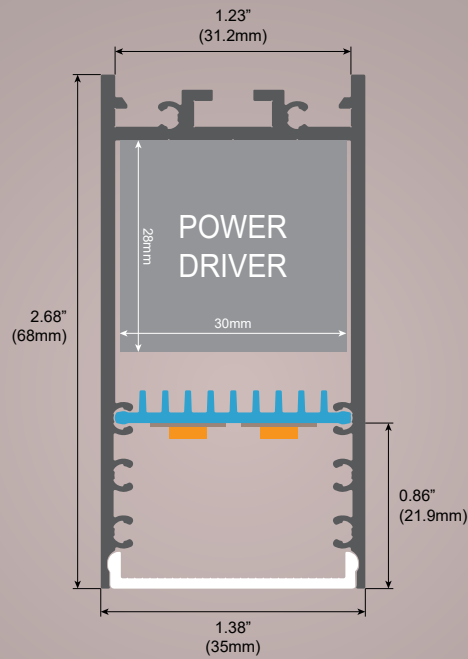

## LS-P35 Suitable for PCB 30mm

- Max. LED power : 11.7w/ft (38.4w/m)
- Installation : Surface / Suspended
- Material : Extruded Aluminium 6063
- Finish : Silver anodised, Black, White
- Diffuser : PMMA flexible diffuser, can be 82'(25m) continuous rolled
- Length : 78.75"(2000mm) or 98.5"(2500mm) continuous
- Size : Profile w1.38"(35mm) x h2.68"(68mm)
- Driver installation : Remote driver required

Custom powder coated colour upon request. Surcharge apply.

Profile sold per metre.

Can be cut to suit any length up to 19' - 8"(6000mm).

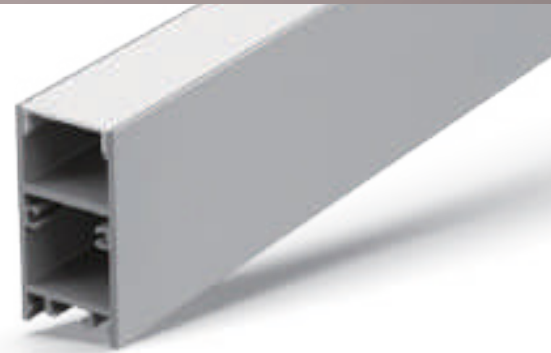

### PMMA Diffuser











CODE: P35-O (OPAL, LIGHT TRANS. >63%)  
 CODE: P35-N (NEW OPAL, LIGHT TRANS. >74%)  
 CODE: P35-F (FROST, LIGHT TRANS. >89%)  
 CODE: P35-C (CLEAR, LIGHT TRANS. >95%)



### Black Diffuser

CODE: WN31-B (BLACK, LIGHT TRANS. >22%)  
 MOQ : 200M

## Installing accessories

	<b>P35 Aluminum Cap</b> CODE : P35-CAP		<b>Metal Clip</b> CODE: P35-CLIP-M		<b>Joiners 90°A</b> CODE: J-90A		<b>30/36/60/100W Dimmable LED Driver</b> CODE:LW-SCD
	<b>P35 CNC Aluminum Cap</b> CODE : P35-CAP-N		<b>Suspension Kits</b> CODE : SUS.KITSA		<b>Joiners 120°A</b> CODE: J-120A		<b>20/30/36/45/60W LED Powersupply</b> CODE: LW-HLD
	<b>Suspension Kits</b> CODE: WN35-WCLIP		<b>Joiners 180°A</b> CODE: J-180A				

# Lumi Stick

Driver Built-in

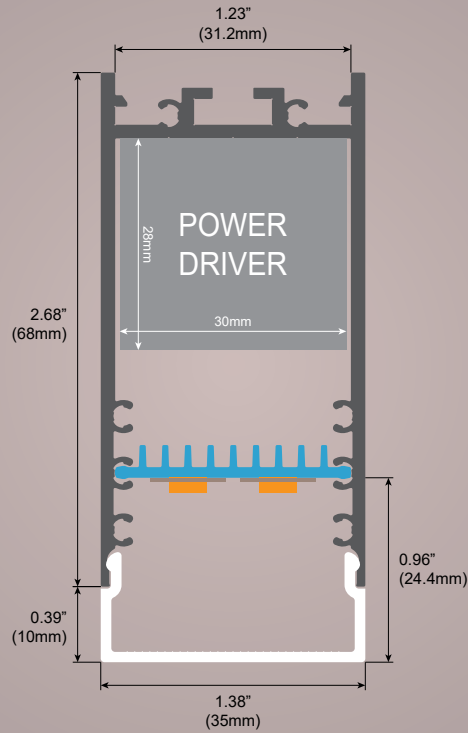

## LS-PU35 Suitable for PCB 30mm

- Max. LED power : 11.7w/ft (38.4w/m)
- Installation : Surface / Suspended
- Material : Extruded Aluminium 6063
- Finish : Silver anodised, Black, White
- Diffuser : PMMA flexible diffuser, can be 82'(25m) continuous rolled
- Length : 78.75"(2000mm) or 98.5"(2500mm) continuous
- Size : Profile w1.38"(35mm) x h3.07"(78mm)
- Driver installation : Remote driver required

Custom powder coated colour upon request. Surcharge apply.





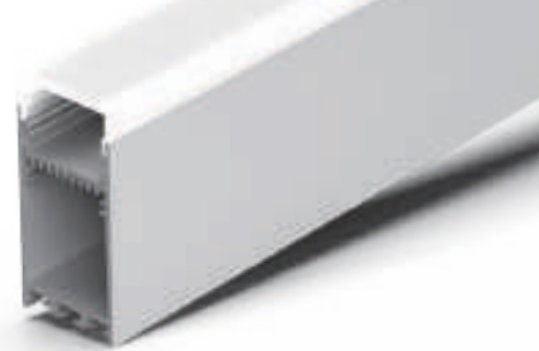





Profile sold per metre.

Can be cut to suit any length up to 19' - 8"(6000mm).



**PMMA Diffuser**  
CODE: PU35-O (OPAL, LIGHT TRANS. >60%)

### Installing accessories

	<b>PU35 Aluminum Cap</b> CODE: PU35-CAP		<b>Metal Clip</b> CODE: P35-CLIP-M		<b>Joiners 90°A</b> CODE: J-90A		<b>30/36/60/100W Dimmable LED Driver</b> CODE: LW-SCD
	<b>P35 CNC Aluminum Cap</b> CODE: P35-CAP-N		<b>Suspension Kits</b> CODE: SUS.KITSA		<b>Joiners 120°A</b> CODE: J-120A		<b>20/30/36/45/60W LED Powersupply</b> CODE: LW-HLD
			<b>Suspension Kits</b> CODE: WN35-WCLIP		<b>Joiners 180°A</b> CODE: J-180A		

# Lumi Stick

Driver Built-in

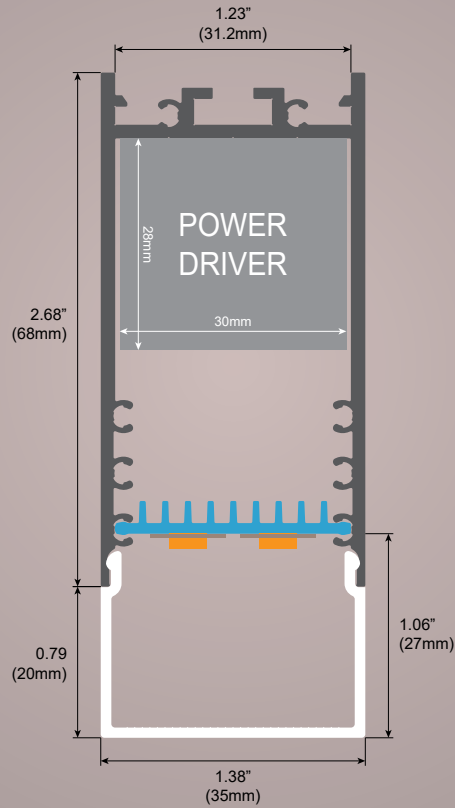

## LS-PUH35 Suitable for PCB 30mm

- Max. LED power : 11.7w/ft (38.4w/m)
- Installation : Surface / Suspended
- Material : Extruded Aluminium 6063
- Finish : Silver anodised, Black, White
- Diffuser : PMMA flexible diffuser, can be 82'(25m) continuous rolled
- Length : 78.75"(2000mm) or 98.5"(2500mm) continuous
- Size : Profile w1.38"(35mm) x h3.47"(88mm)
- Driver installation : Remote driver required

Custom powder coated colour upon request. Surcharge apply.





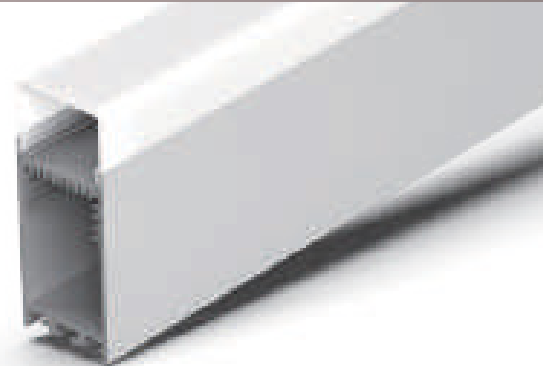





Profile sold per metre.

Can be cut to suit any length up to 19' - 8"(6000mm).



**PMMA Diffuser**  
CODE: PUH35-O (OPAL, LIGHT TRANS. >60%)

### Installing accessories

	<b>PUH35 Aluminum Cap</b> CODE: PUH35-CAP		<b>Metal Clip</b> CODE: P35-CLIP-M		<b>Joiners 90°A</b> CODE: J-90A		<b>30/36/60/100W Dimmable LED Driver</b> CODE: LW-SCD
	<b>P35 CNC Aluminum Cap</b> CODE: P35-CAP-N		<b>Suspension Kits</b> CODE: SUS.KITSA		<b>Joiners 120°A</b> CODE: J-120A		<b>20/30/36/45/60W LED Powersupply</b> CODE: LW-HLD
			<b>Suspension Kits</b> CODE: WN35-WCLIP		<b>Joiners 180°A</b> CODE: J-180A		

# Lumi Stick

Driver Built-in

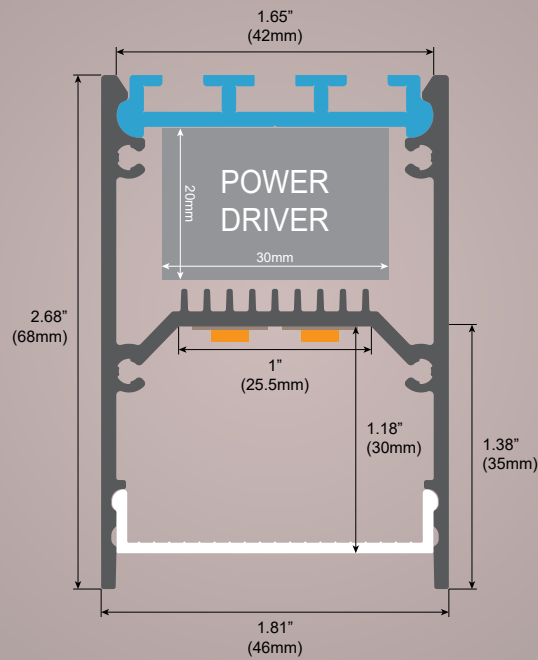

## LS-P46 Suitable for PCB 25mm

- Max. LED power : 11.7w/ft (38.4w/m)
- Installation : Surface / Suspended
- Material : Extruded Aluminium 6063
- Finish : Silver anodised, Black, White
- Diffuser : PMMA flexible diffuser, can be 82'(25m) continuous rolled
- Length : 78.75"(2000mm) or 98.5"(2500mm) continuous
- Size : Profile w1.81"(46mm) x h2.68"(68mm)
- Driver installation : Remote driver required

Custom powder coated colour upon request. Surcharge apply.

Profile sold per metre.







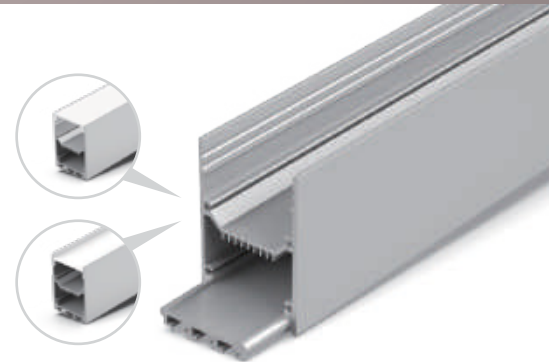

Can be cut to suit any length up to 19' - 8"(6000mm).



**PMMA Diffuser**  
CODE: P46-O (OPAL, LIGHT TRANS. >60%)



### Installing accessories

	<b>P46 Aluminum Cap</b> CODE: P46-CAP		<b>Suspension Kits</b> CODE: SUS.KITSA		<b>Joiners 90°A</b> CODE: J-90A		<b>30/36/60/100W Dimmable LED Driver</b> CODE: LW-SCD
	<b>P46 CNC Aluminum Cap</b> CODE: P46-CAP-N		<b>Suspension Kits</b> CODE: WN35-WCLIP		<b>Joiners 120°A</b> CODE: J-120A		<b>20/30/36/45/60W LED Powersupply</b> CODE: LW-HLD
					<b>Joiners 180°A</b> CODE: J-180A		

# Lumi Stick

Driver Built-in

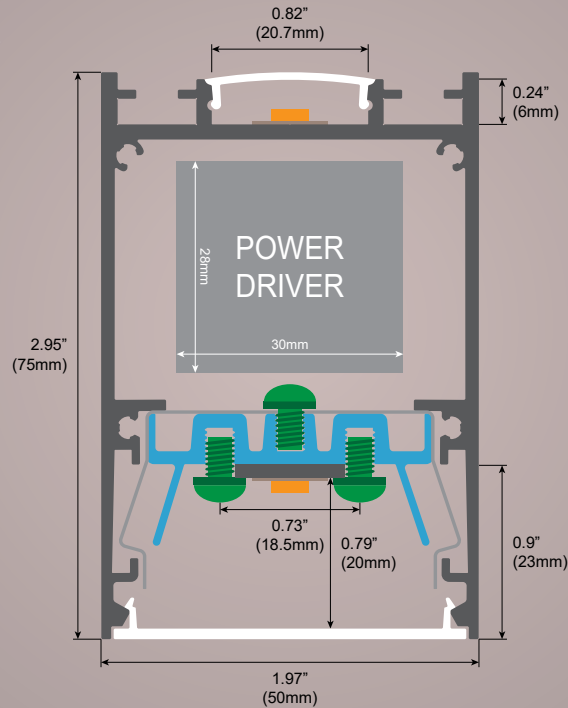

## LS-P50N Suitable for PCB 18mm

- Max. LED power : 17.6w/ft (57.6w/m)
- Installation : Surface / Suspended
- Material : Extruded Aluminium 6063
- Finish : Silver anodised, Black, White
- Diffuser : PMMA flexible diffuser, can be 82'(25m) continuous rolled
- Length : 78.75"(2000mm) or 98.5"(2500mm) continuous
- Size : Profile w1.97"(50mm) x h2.95"(75mm)
- Driver installation : Remote driver required

Custom powder coated colour upon request. Surcharge apply.

Profile sold per metre.

Can be cut to suit any length up to 19' - 8"(6000mm).

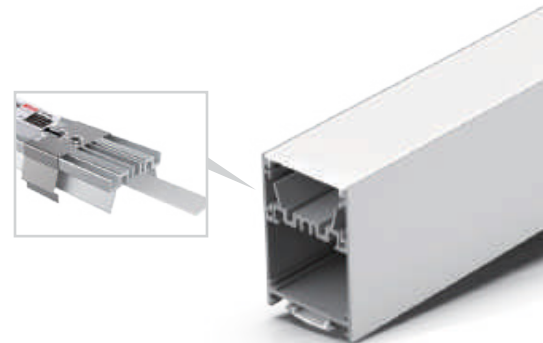

### PMMA Diffuser (Down)

CODE: P50N-O (OPAL, LIGHT TRANS. >60%)  
CODE: P50N-N (NEW OPAL, LIGHT TRANS. >74%)



### PMMA Diffuser (Up)

CODE: P50N-O (OPAL, LIGHT TRANS. >60%)  
CODE: P50N-N (NEW OPAL, LIGHT TRANS. >74%)



### Black Diffuser

CODE: E50-B (BLACK, LIGHT TRANS. >22%)  
MOQ : 200M

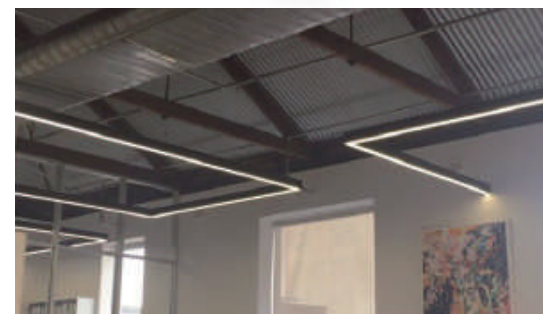

## Installing accessories

	<b>P50N CNC Aluminum Cap</b> CODE: P50N-CAP-N		<b>Metal Clip</b> CODE: P50N-CLIP-M		<b>Joiners 90°A &amp; B</b> CODE: J-90A & B		<b>30/36/60/100W Dimmable LED Driver</b> CODE: LW-SCD
	<b>P50N Gear Tray Clip</b> CODE: P50N-CLIP		<b>Suspension Kits</b> CODE: SUS.KITSB		<b>Joiners 120°A &amp; B</b> CODE: J-120A & B		<b>20/30/36/45/60W LED Powersupply</b> CODE: LW-HLD
	<b>Stainless L bracket</b> CODE: LW-LMB		<b>Wall Clips</b> CODE: WCLIP		<b>Joiners 180°A</b> CODE: J-180A		

# Lumi Stick

Driver Built-in

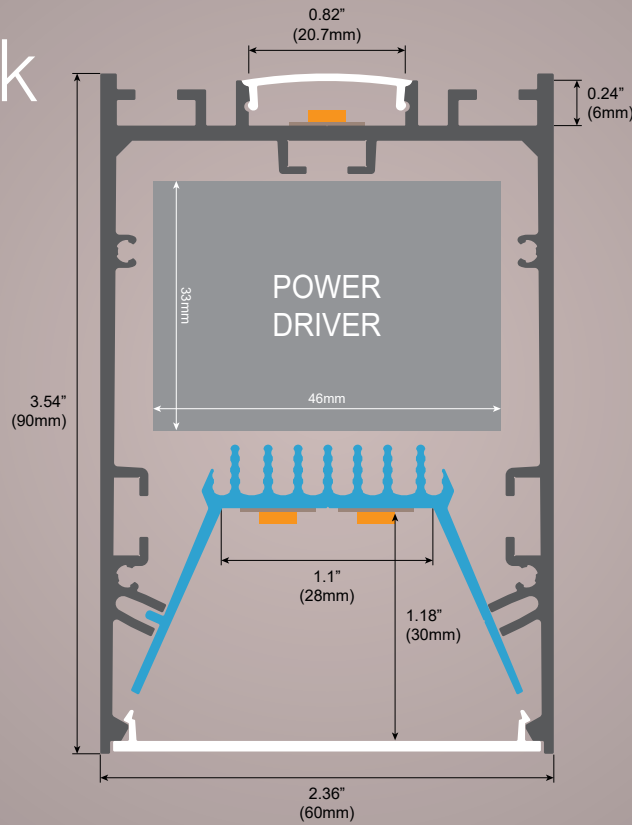

## LS-P60 Suitable for PCB 28mm

- Max. LED power : 17.6w/ft (57.6w/m)
- Installation : Surface / Suspended
- Material : Extruded Aluminium 6063
- Finish : Silver anodised, Black, White
- Diffuser : PMMA flexible diffuser, can be 82'(25m) continuous rolled
- Length : 78.75"(2000mm) or 98.5"(2500mm) continuous
- Size : Profile w2.36"(60mm) x h3.54"(90mm)
- Driver installation : Remote driver required

Custom powder coated colour upon request. Surcharge apply.

Profile sold per metre.

Can be cut to suit any length up to 19' - 8"(6000mm).











**PMMA Diffuser (Down)**  
CODE: P60-N (NEW OPAL, LIGHT TRANS. >74%)



**PMMA Diffuser (Up)**  
CODE: AS3-O (NEW OPAL, LIGHT TRANS. >74%)



### Installing accessories

	<b>P60 Aluminum Endcap</b> CODE: P60-CAP		<b>Suspension Kits</b> CODE: SUS.KITSB		<b>Joiners 90°A &amp; B</b> CODE: J-90A & B		<b>30/36/60/100W Dimmable LED Driver</b> CODE: LW-SCD
	<b>P60 CNC Aluminum Cap</b> CODE: P60-CAP-N		<b>Wall Clips</b> CODE: WCLIP		<b>Joiners 120°A &amp; B</b> CODE: J-120A & B		<b>20/30/36/45/60W LED Powersupply</b> CODE: LW-HLD
					<b>Joiners 180°A</b> CODE: J-180A		

Profile :  
w3.15"(80mm)  
h3.94"(100mm)

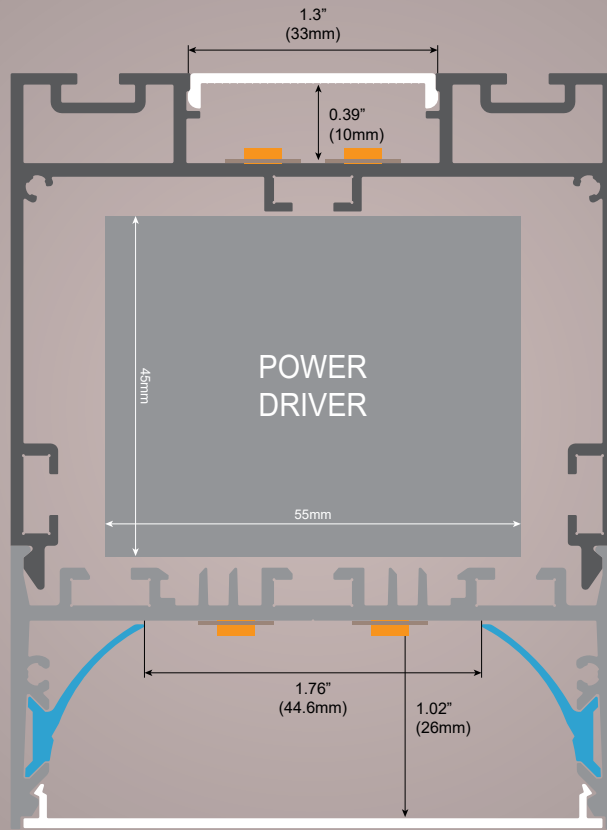

## LS-EH80 Suitable for PCB 44mm

- Max. LED power : 17.6w/ft (57.6w/m)
- Installation : Surface / Suspended
- Material : Extruded Aluminium 6063
- Finish : Silver anodised, Black, White
- Diffuser : PMMA flexible diffuser, can be 82'(25m) continuous rolled
- Length : 78.75"(2000mm) or 98.5"(2500mm) continuous
- Size : Profile w3.15"(80mm) x h3.94"(100mm)
- Driver installation : Remote driver required

Custom powder coated colour upon request. Surcharge apply.

Profile sold per metre.

Can be cut to suit any length up to 19' - 8"(6000mm).

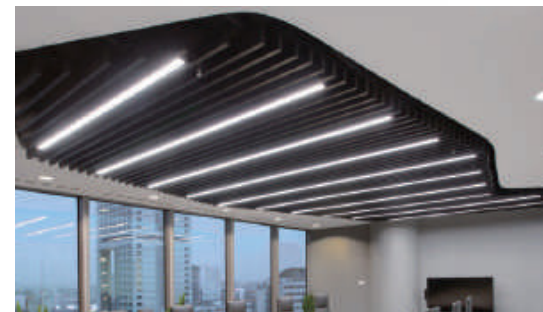









**PMMA Diffuser (Down)**  
CODE: EH80-N (NEW OPAL, LIGHT TRANS. >74%)



**PMMA Diffuser (Up)**  
CODE: EH80-N (NEW OPAL, LIGHT TRANS. >74%)

### Installing accessories

	<b>EH80 Aluminum Endcap</b> CODE: EH80-CAP		<b>Suspension Kits</b> CODE: SUS.KITSB		<b>Joiners 90°A &amp; B</b> CODE: J-90A & B		<b>30/36/60/100W Dimmable LED Driver</b> CODE: LW-SCD
	<b>EH80 CNC Aluminum Cap</b> CODE: EH80-CAP-N		<b>Wall Clips</b> CODE: WCLIP		<b>Joiners 120°A &amp; B</b> CODE: J-120A & B		<b>20/30/36/45/60W LED Powersupply</b> CODE: LW-HLD
					<b>Joiners 180°A</b> CODE: J-180A		

# Lumi Stick

Driver Built-in

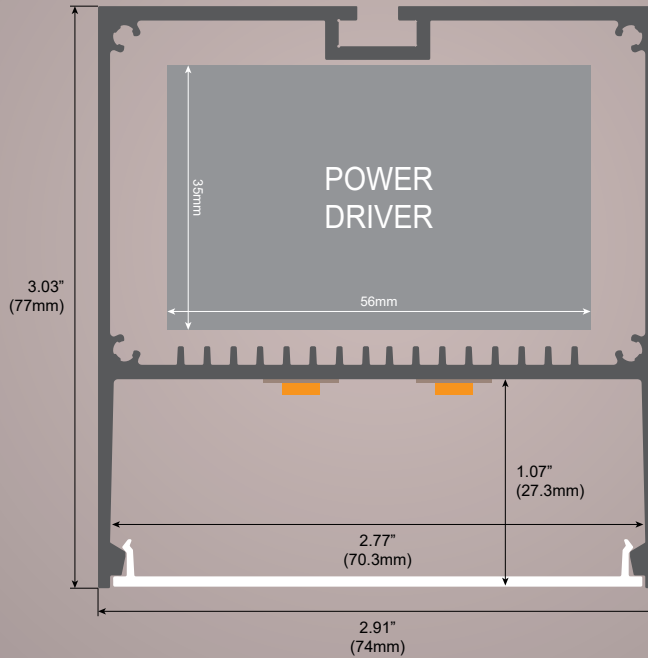

## LS-P70 Suitable for PCB 70mm

- Max. LED power : 17.6w/ft (57.6w/m)
- Installation : Surface / Suspended
- Material : Extruded Aluminium 6063
- Finish : Silver anodised, Black, White
- Diffuser : PMMA flexible diffuser, can be 82'(25m) continuous rolled
- Length : 78.75'(2000mm) or 98.5'(2500mm) continuous
- Size : Profile w2.91"(74mm) x h3.03"(77mm)
- Driver installation : Remote driver required

Custom powder coated colour upon request. Surcharge apply.





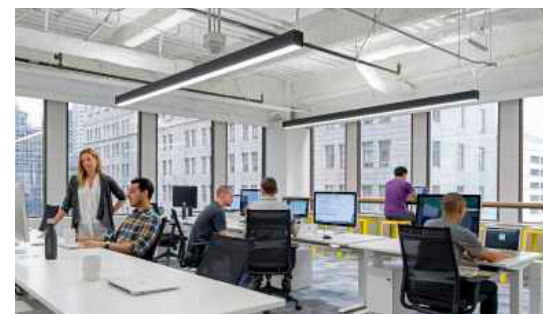
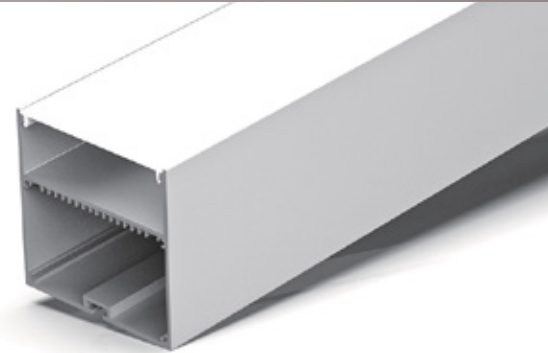



Profile sold per metre.

Can be cut to suit any length up to 19' - 8"(6000mm).



**PMMA Diffuser**  
CODE: P74-N (NEW OPAL, LIGHT TRANS. >77%)



### Installing accessories

	<b>P70 Aluminum Endcap</b> CODE: P70-CAP		<b>Suspension Kits</b> CODE: SUS.KITSB		<b>Joiners 90°A</b> CODE: J-90A		<b>30/36/60/100W Dimmable LED Driver</b> CODE: LW-SCD
	<b>Wall Clips</b> CODE: WCLIP		<b>Joiners 120°A</b> CODE: J-120A		<b>20/30/36/45/60W LED Powersupply</b> CODE: LW-HLD		
			<b>Joiners 180°A</b> CODE: J-180A				





## Round

			
<b>Model Number</b>	LS-R30	LS-R34	LS-R60
<b>Dimension(WxH)</b>	Φ1.18"	Φ1.34"	Φ2.36"
<b>Max. LED Power</b>	8.8W / ft	8.8W / ft	8.8W / ft
<b>Max. Length</b>	13' - 1"	16' - 4"	19' - 8"
<b>Pages</b>	P. 42	P. 43	P. 44

# Lumi Stick

Round

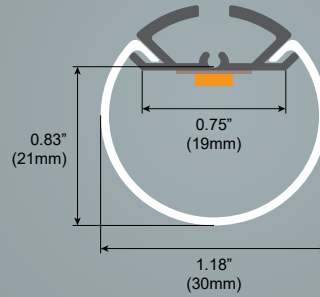

## LS-R30 Suitable for PCB 18mm

- Max. LED power : 8.8w/ft (28.8w/m)
- Installation : Surface / Suspended
- Material : Extruded Aluminium 6063
- Finish : Silver anodised, Black, White
- Diffuser : PMMA flexible diffuser, can be 82'(25m) continuous rolled
- Length : 78.75"(2000mm) or 98.5"(2500mm) continuous
- Size : Profile  $\Phi$ 1.18"(30mm)
- Driver installation : Remote driver required

Custom powder coated colour upon request. Surcharge apply.

Profile sold per metre.

Can be cut to suit any length up to 13' - 1"(4000mm).



**PC Diffuser**  
CODE: R30-O (OPAL, LIGHT TRANS. >50%)



### Installing accessories



**R30  
Plastic Endcap**  
CODE: R30-CAP  
CODE: R30-CAP-H



**Suspension Kits**  
CODE : SUS.KITSA

# Lumi Stick

Round

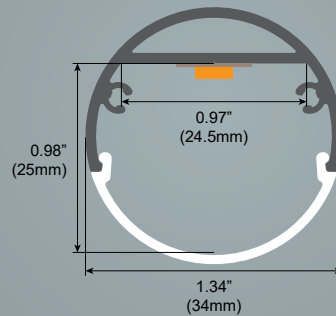

## LS-R34 Suitable for PCB 24mm

- Max. LED power : 8.8w/ft (28.8w/m)
- Installation : Surface / Suspended
- Material : Extruded Aluminium 6063
- Finish : Silver anodised, Black, White
- Diffuser : PMMA flexible diffuser, can be 82'(25m) continuous rolled
- Length : 78.75"(2000mm) or 98.5"(2500mm) continuous
- Size : Profile  $\Phi$ 1.34"(34mm)
- Driver installation : Remote driver required

Custom powder coated colour upon request. Surcharge apply.

Profile sold per metre.

Can be cut to suit any length up to 13' - 1"(4000mm).



### PC Diffuser

CODE: R34-O (OPAL, LIGHT TRANS. >50%)

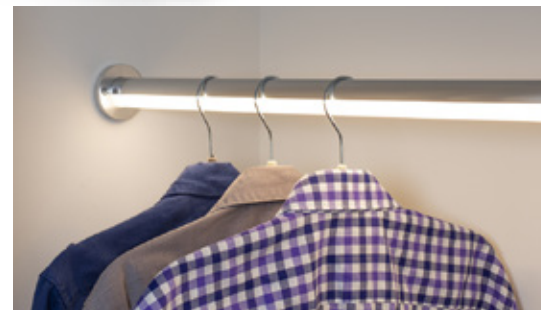

## Installing accessories



### R34

#### Aluminium Endcap

CODE: R34-CAP  
CODE: R34-CAP-H



#### Wall Bracket

CODE: R34-A



#### Supporter

CODE: R34-B

# Lumi Stick

Round

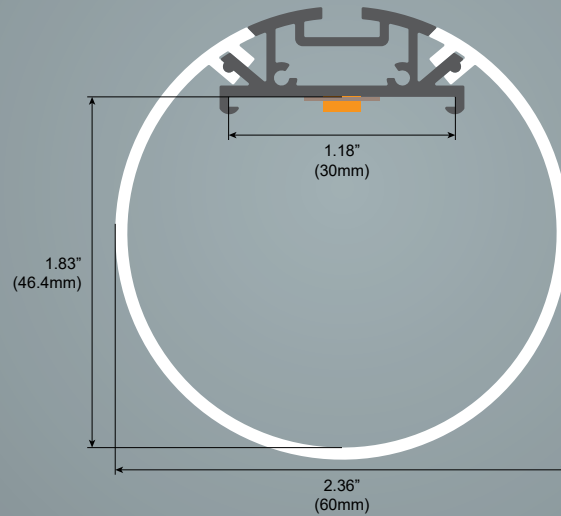

## LS-R60 Suitable for PCB 30mm

- Max. LED power : 8.8w/ft (28.8w/m)
- Installation : Surface / Suspended
- Material : Extruded Aluminium 6063
- Finish : Silver anodised, Black, White
- Diffuser : PMMA flexible diffuser, can be 82'(25m) continuous rolled
- Length : 78.75"(2000mm) or 98.5"(2500mm) continuous
- Size : Profile  $\Phi$ 2.36"(60mm)
- Driver installation : Remote driver required

Custom powder coated colour upon request. Surcharge apply.

Profile sold per metre.

Can be cut to suit any length up to 13' - 1"(4000mm).



### PC Diffuser

CODE: R60-O (OPAL, LIGHT TRANS. >50%)

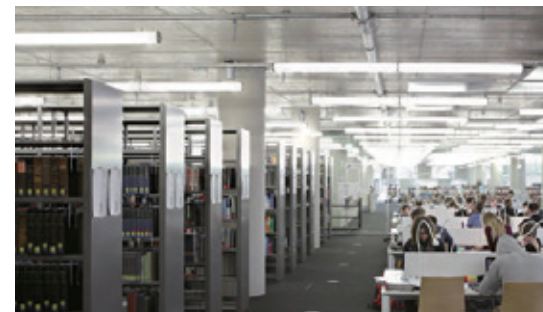

## Installing accessories



**R60**  
Plastic Endcap  
CODE: R60-CAP

















**Suspension Kits**  
CODE: SUS.KITSA



**R60**  
Aluminium Endcap  
CODE: R60-CAP



## Architectural Surface & Suspension

								
<b>Model Number</b>	LS-P24	LS-WN35	LS-WU35	LS-WUH35	LS-WN35-25	LS-WU35-25	LS-WUH35-25	LS-E50
<b>Dimension(WxH)</b>	0.98" x 4.72"	1.38" x 1.48"	1.38" x 1.87"	1.38" x 2.26"	1.38" x 1"	1.38" x 1.39"	1.38" x 1.79"	1.97" x 1.48"
<b>Max. LED Power</b>	11.7W / ft	11.7W / ft	11.7W / ft	11.7W / ft	11.7W / ft	11.7W / ft	11.7W / ft	11.7W / ft
<b>Max. Length</b>	13' - 1"	19' - 8"	19' - 8"	19' - 8"	19' - 8"	19' - 8"	19' - 8"	19' - 8"
<b>Pages</b>	P. 46	P. 47	P. 48	P. 49	P. 50	P. 51	P. 52	P. 53
								
<b>Model Number</b>	LS-EU50	LS-E60	LS-EU60	LS-E80	LS-EU80	LS-E100	LS-W91	
<b>Dimension(WxH)</b>	1.97" x 1.87"	2.36" x 1.48"	2.36" x 1.87"	3.15" x 1.48"	3.15" x 2.07"	4.02" x 1.22"	3.54" x 1.48"	
<b>Max. LED Power</b>	11.7W / ft	11.7W / ft	17.6W / ft	17.6W / ft	17.6W / ft	17.6W / ft	17.6W / ft	
<b>Max. Length</b>	13' - 1"	19' - 8"	19' - 8"	19' - 8"	19' - 8"	19' - 8"	19' - 8"	
<b>Pages</b>	P. 54	P. 55	P. 56	P. 57	P. 58	P. 59	P. 60	

# Lumi Stick

Architectural Surface  
& Suspension



## LS-P24 Suitable for PCB 24mm

- Max. LED power : 11.7w/ft (38.4w/m)
- Installation : Surface / Suspended
- Material : Extruded Aluminium 6063
- Finish : Silver anodised, Black, White
- Diffuser : PMMA flexible diffuser, can be 82'(25m) continuous rolled
- Length : 78.75"(2000mm) or 98.5"(2500mm) continuous
- Size : Profile w0.98"(25mm) x h4.72"(120mm)
- Driver installation : Remote driver required

Custom powder coated colour upon request. Surcharge apply.

Profile sold per metre.

Can be cut to suit any length up to 19' - 8"(6000mm).



**PMMA Diffuser**  
CODE: P24-O (OPAL, LIGHT TRANS. >55%)

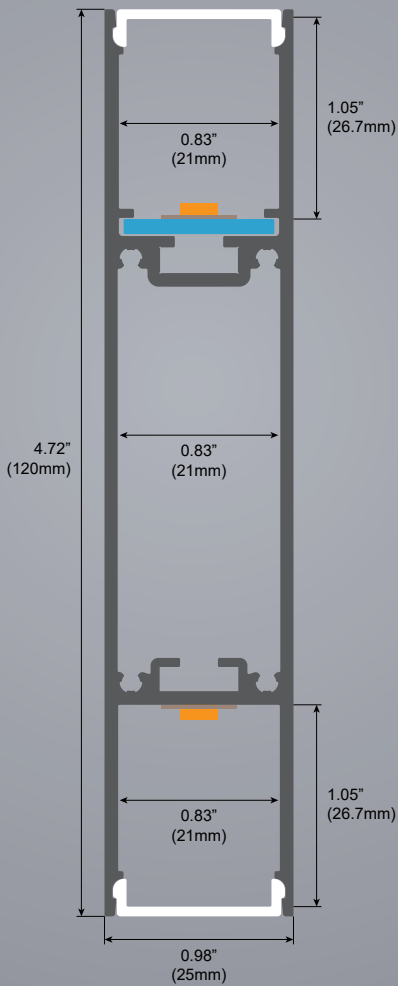

### Installing accessories



**P24**  
**CNC Aluminum Cap**  
CODE: P24-CAP-N



**Suspension Kits**  
CODE: SUS.KITSA



**Suspension Kits**  
CODE: WN35-WCLIP



**Joiners 90°A**  
CODE: J-90A



**Joiners 120°A**  
CODE: J-120A



**Joiners 180°A**  
CODE: J-180A

# Lumi Stick

Architectural Surface & Suspension

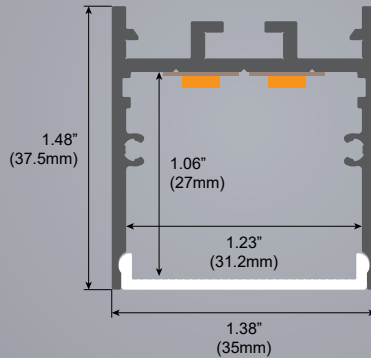

## LS-WN35 Suitable for PCB 20mm

- Max. LED power : 11.7w/ft (38.4w/m)
- Installation : Surface / Suspended
- Material : Extruded Aluminium 6063
- Finish : Silver anodised, Black, White
- Diffuser : PMMA flexible diffuser, can be 82'(25m) continuous rolled
- Length : 78.75"(2000mm) or 98.5"(2500mm) continuous
- Size : Profile w1.38"(35mm) x h1.48"(37.5mm)
- Driver installation : Remote driver required

Custom powder coated colour upon request. Surcharge apply.

Profile sold per metre.

Can be cut to suit any length up to 19' - 8"(6000mm).

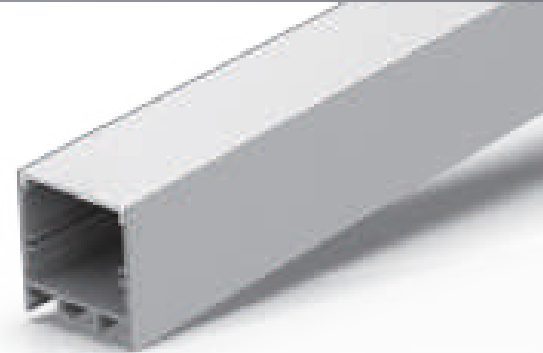

### PMMA Diffuser

CODE: WN35-O (OPAL, LIGHT TRANS. >63%)  
 CODE: WN35-N (NEW OPAL, LIGHT TRANS. >74%)  
 CODE: WN35-F (FROST, LIGHT TRANS. >89%)  
 CODE: WN35-C (CLEAR, LIGHT TRANS. >95%)







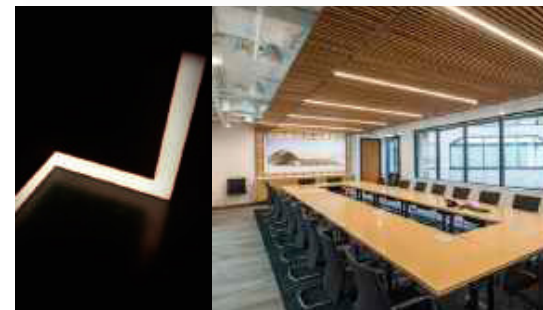



### Black Diffuser

CODE: WN31-B (BLACK, LIGHT TRANS. >22%)  
 MOQ : 200M



## Installing accessories

	<b>WN35 Aluminium Endcap</b> CODE: WN35-CAP CODE: WN35-CAP-H		<b>Metal Clip</b> CODE: MC-WN35		<b>Joiners 90°A</b> CODE: J-90A
	<b>WN35 CNC Aluminum Cap</b> CODE: WN35-CAP-N		<b>Suspension Kits</b> CODE: SUS.KITSA		<b>Joiners 120°A</b> CODE: J-120A
	<b>Wall Clips</b> CODE: WCLIP-WN-35		<b>Joiners 180°A</b> CODE: J-180A		<b>Aluminium Diffuser</b> CODE: WN35-AD

# LumiStick

Architectural Surface & Suspension

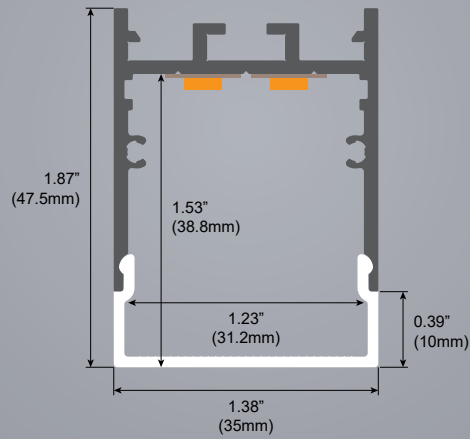

## LS-WU35 Suitable for PCB 30mm

- Max. LED power : 11.7w/ft (38.4w/m)
- Installation : Surface / Suspended
- Material : Extruded Aluminium 6063
- Finish : Silver anodised, Black, White
- Diffuser : PMMA flexible diffuser, can be 82'(25m) continuous rolled
- Length : 78.75'(2000mm) or 98.5'(2500mm) continuous
- Size : Profile w1.38'(35mm) x h1.87'(47.5mm)
- Driver installation : Remote driver required

Custom powder coated colour upon request. Surcharge apply.

Profile sold per metre.

Can be cut to suit any length up to 19' - 8"(6000mm).

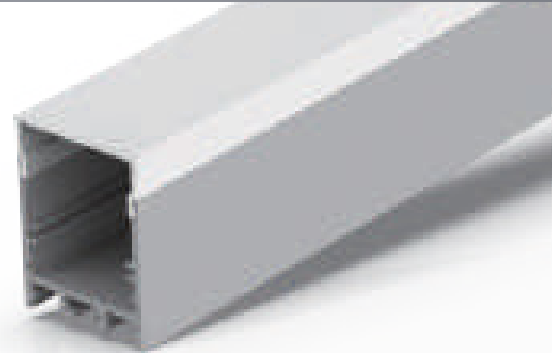

**PMMA Diffuser**  
CODE: WU35-O (OPAL, LIGHT TRANS. >60%)

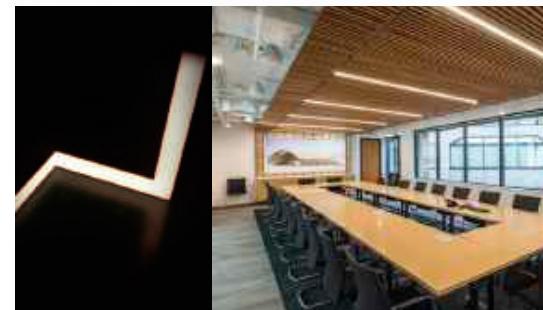

### Installing accessories

	<b>WU35 Aluminium Endcap</b> CODE: WU35-CAP		<b>Metal Clip</b> CODE: MC-WN35		<b>Joiners 90°A</b> CODE: J-90A
	<b>Suspension Kits</b> CODE: SUS.KITSA		<b>Joiners 120°A</b> CODE: J-120A		<b>Joiners 180°A</b> CODE: J-180A
	<b>Wall Clips</b> CODE: WCLIP-WN-35		<b>Aluminium Diffuser</b> CODE: WN35-AD		



# Lumi Stick

Architectural Surface & Suspension

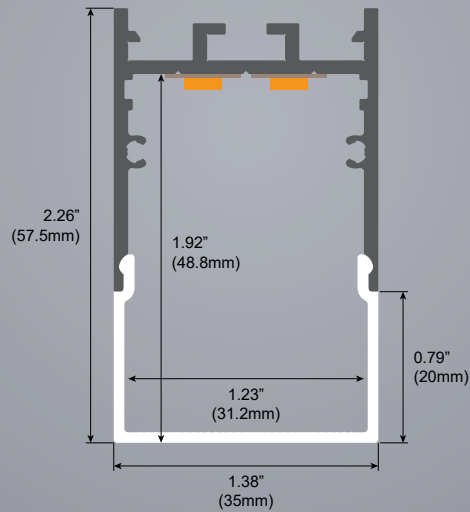

## LS-WUH35 Suitable for PCB 30mm

- Max. LED power : 11.7w/ft (38.4w/m)
- Installation : Surface / Suspended
- Material : Extruded Aluminium 6063
- Finish : Silver anodised, Black, White
- Diffuser : PMMA flexible diffuser, can be 82'(25m) continuous rolled
- Length : 78.75"(2000mm) or 98.5"(2500mm) continuous
- Size : Profile w1.38"(35mm) x h2.26"(57.5mm)
- Driver installation : Remote driver required

Custom powder coated colour upon request. Surcharge apply.

Profile sold per metre.

Can be cut to suit any length up to 19' - 8"(6000mm).

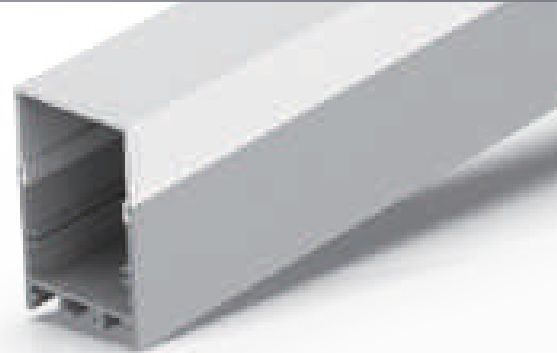

**PMMA Diffuser**  
CODE: WUH35-O (OPAL, LIGHT TRANS. >60%)

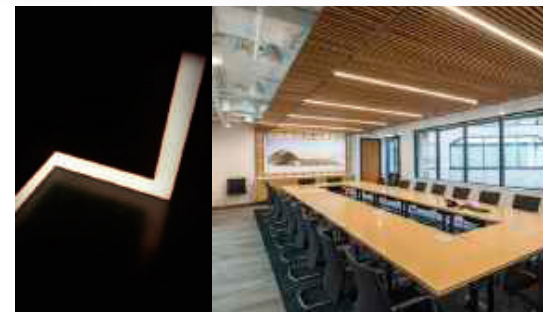

### Installing accessories

	<b>WUH35 Aluminium Endcap</b> CODE: WUH35-CAP		<b>Metal Clip</b> CODE: MC-WN35		<b>Joiners 90°A</b> CODE: J-90A
	<b>Suspension Kits</b> CODE: SUS.KITSA		<b>Joiners 120°A</b> CODE: J-120A		<b>Joiners 180°A</b> CODE: J-180A
	<b>Wall Clips</b> CODE: WCLIP-WN-35		<b>Aluminium Diffuser</b> CODE: WN35-AD		

# Lumi Stick

Architectural Surface & Suspension

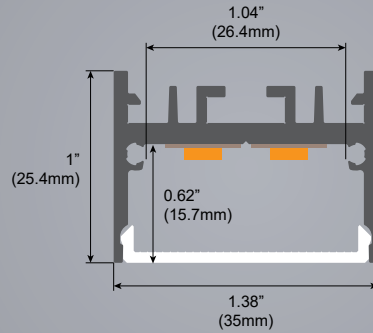

## LS-WN35-25 Suitable for PCB 30mm

- Max. LED power : 11.7w/ft (38.4w/m)
- Installation : Surface / Suspended
- Material : Extruded Aluminium 6063
- Finish : Silver anodised, Black, White
- Diffuser : PMMA flexible diffuser, can be 82'(25m) continuous rolled
- Length : 78.75"(2000mm) or 98.5"(2500mm) continuous
- Size : Profile w1.38"(35mm) x h1"(25.4mm)
- Driver installation : Remote driver required

Custom powder coated colour upon request. Surcharge apply.

Profile sold per metre.

Can be cut to suit any length up to 19' - 8"(6000mm).

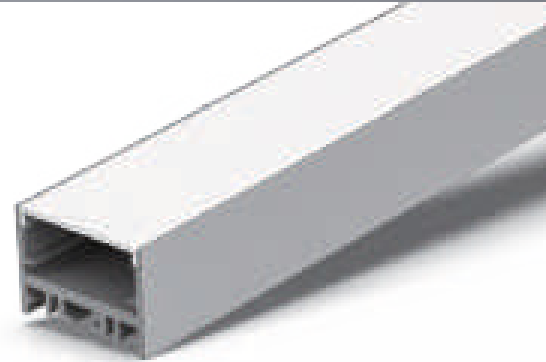

### PMMA Diffuser

CODE: WN35-25-O (OPAL, LIGHT TRANS. >63%)  
 CODE: WN35-25-N (NEW OPAL, LIGHT TRANS. >74%)  
 CODE: WN35-25-F (FROST, LIGHT TRANS. >89%)  
 CODE: WN35-25-C (CLEAR, LIGHT TRANS. >95%)

### Installing accessories



**WN35-25**  
**Aluminium Endcap**  
 CODE: WN35-25-CAP  
 CODE: WN35-25-CAP-H



**Metal Clip**  
 CODE: MC-WN35



**Joiners 90°A**  
 CODE: J-90A



**Suspension Kits**  
 CODE: SUS.KITSA



**Joiners 120°A**  
 CODE: J-120A



**Joiners 180°A**  
 CODE: J-180A

# Lumi Stick

Architectural Surface & Suspension

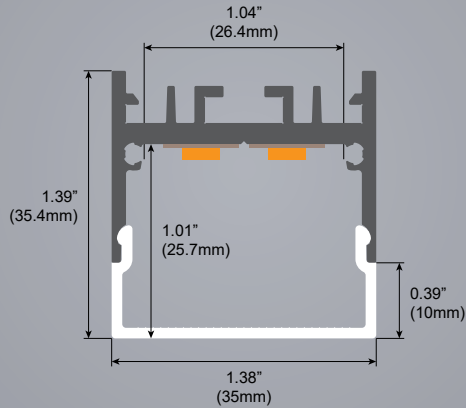

## LS-WU35-25 Suitable for PCB 25mm

- Max. LED power : 11.7w/ft (38.4w/m)
- Installation : Surface / Suspended
- Material : Extruded Aluminium 6063
- Finish : Silver anodised, Black, White
- Diffuser : PMMA flexible diffuser, can be 82'(25m) continuous rolled
- Length : 78.75'(2000mm) or 98.5'(2500mm) continuous
- Size : Profile w1.38'(35mm) x h1.39'(35.4mm)
- Driver installation : Remote driver required

Custom powder coated colour upon request. Surcharge apply.

Profile sold per metre.

Can be cut to suit any length up to 19' - 8"(6000mm).

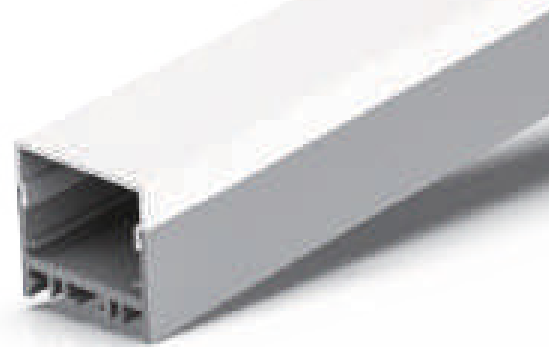

**PMMA Diffuser**  
CODE: WU35-25-O (OPAL, LIGHT TRANS. >63%)

### Installing accessories



**WU35-25**  
**Aluminium Endcap**  
CODE: WU35-25-CAP



**Metal Clip**  
CODE: MC-WN35



**Joiners 90°A**  
CODE: J-90A



**Suspension Kits**  
CODE: SUS.KITSA



**Joiners 120°A**  
CODE: J-120A



**Joiners 180°A**  
CODE: J-180A

# Lumi Stick

Architectural Surface & Suspension

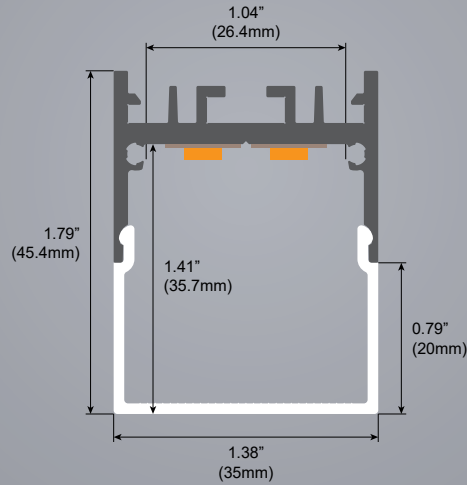

## LS-WUH35-25 Suitable for PCB 25mm

- Max. LED power : 11.7w/ft (38.4w/m)
- Installation : Surface / Suspended
- Material : Extruded Aluminium 6063
- Finish : Silver anodised, Black, White
- Diffuser : PMMA flexible diffuser, can be 82'(25m) continuous rolled
- Length : 78.75'(2000mm) or 98.5'(2500mm) continuous
- Size : Profile w1.38'(35mm) x h1.79'(45.4mm)
- Driver installation : Remote driver required

Custom powder coated colour upon request. Surcharge apply.

Profile sold per metre.

Can be cut to suit any length up to 19' - 8"(6000mm).

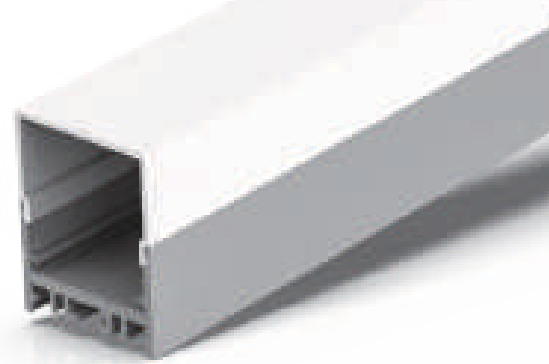

**PMMA Diffuser**  
CODE: WUH35-25-O (OPAL, LIGHT TRANS. >60%)

### Installing accessories



**WUH35-25**  
**Aluminium Endcap**  
CODE: WUH35-25-CAP



**Metal Clip**  
CODE: MC-WN35



**Joiners 90°A**  
CODE: J-90A



**Suspension Kits**  
CODE: SUS.KITSA



**Joiners 120°A**  
CODE: J-120A



**Joiners 180°A**  
CODE: J-180A

# Lumi Stick

Architectural Surface & Suspension

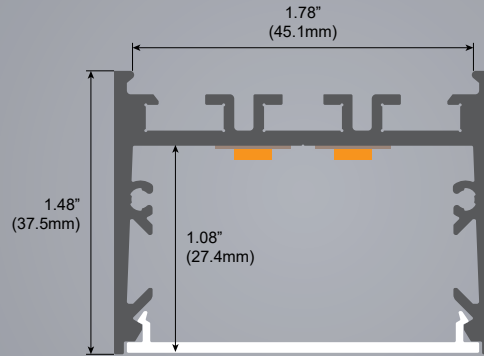

## LS-E50 Suitable for PCB 40mm

- Max. LED power : 11.7w/ft (38.4w/m)
- Installation : Surface / Suspended
- Material : Extruded Aluminium 6063
- Finish : Silver anodised, Black, White
- Diffuser : PMMA flexible diffuser, can be 82'(25m) continuous rolled
- Length : 78.75"(2000mm) or 98.5"(2500mm) continuous
- Size : Profile w1.97"(50mm) x h1.48"(37.5mm)
- Driver installation : Remote driver required

Custom powder coated colour upon request. Surcharge apply.

Profile sold per metre.

Can be cut to suit any length up to 19' - 8"(6000mm).

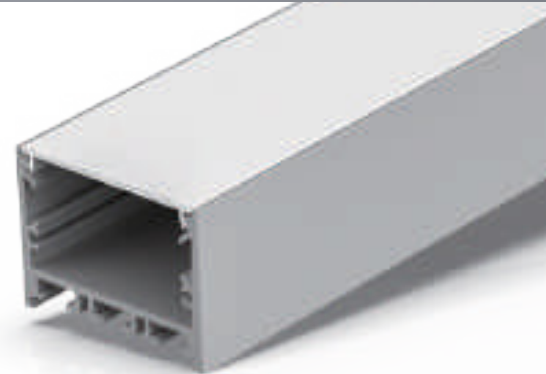

### PMMA Diffuser

CODE: E50-O (OPAL, LIGHT TRANS. >60%)  
CODE: E50-N (NEW OPAL, LIGHT TRANS. >74%)







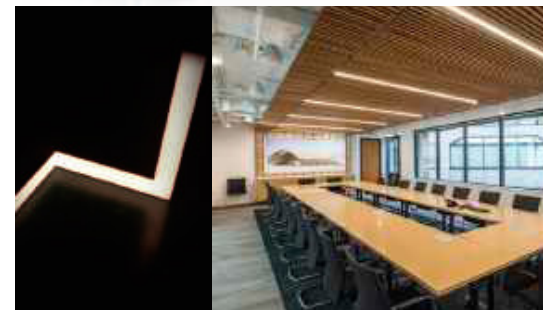



### Black Diffuser

CODE: E50-B (BLACK, LIGHT TRANS. >22%)  
MOQ:200M



## Installing accessories

	<b>E50 Aluminium Endcap</b> CODE: E50-CAP CODE: E50-CAP-H		<b>Wall Clips</b> CODE: WCLIP		<b>Joiners 90°A</b> CODE: J-90A
	<b>E50 CNC Aluminium Cap</b> CODE: E50-CAP-N		<b>Suspension Kits</b> CODE: SUS.KITSA		<b>Joiners 120°A</b> CODE: J-120A
	<b>Aluminium Diffuser</b> CODE: E50-AD		<b>Joiners 180°A</b> CODE: J-180A		<b>Joiners 180°B</b> CODE: J-180B

# Lumi Stick

Architectural Surface & Suspension

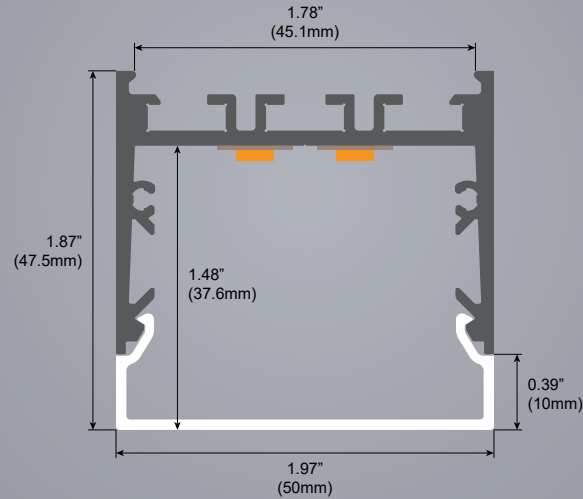

## LS-EU50 Suitable for PCB 30mm

- Max. LED power : 17.6w/ft (57.6w/m).
- Installation : Surface / Suspended
- Material : Extruded Aluminium 6063
- Finish : Silver anodised, Black, White
- Diffuser : PMMA flexible diffuser, can be 82'(25m) continuous rolled
- Length : 78.75'(2000mm) or 98.5'(2500mm) continuous
- Size : Profile w1.97'(50mm) x h1.87'(47.5mm)
- Driver installation : Remote driver required

Custom powder coated colour upon request. Surcharge apply.

Profile sold per metre.





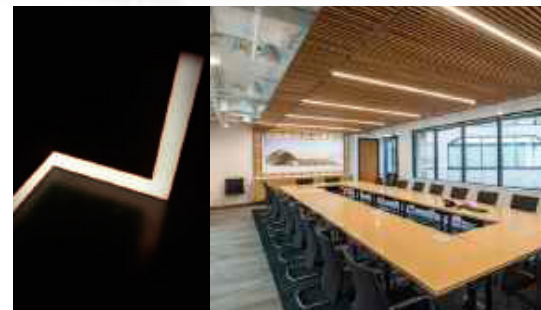

Can be cut to suit any length up to 19' - 8"(6000mm).



**PMMA Diffuser**  
CODE: EU50-O (OPAL, LIGHT TRANS. >60%)



### Installing accessories

 <p><b>EU50 Aluminium Endcap</b> CODE: EU50-CAP CODE: EU50-CAP-H</p>	 <p><b>Wall Clips</b> CODE: WCLIP</p>	 <p><b>Joiners 90°A</b> CODE: J-90A</p>
 <p><b>Suspension Kits</b> CODE: SUS.KITSA</p>	 <p><b>Joiners 120°A</b> CODE: J-120A</p>	 <p><b>Joiners 180°A</b> CODE: J-180A</p>

# Lumi Stick

Architectural Surface & Suspension

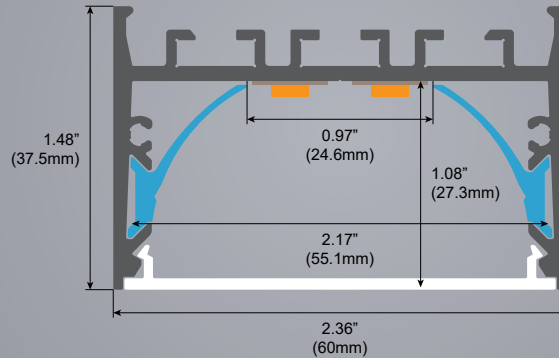

## LS-E60 Suitable for PCB 25mm

- Max. LED power : 17.6w/ft (57.6w/m)
- Installation : Surface / Suspended
- Material : Extruded Aluminium 6063
- Finish : Silver anodised, Black, White
- Diffuser : PMMA flexible diffuser, can be 82'(25m) continuous rolled
- Length : 78.75"(2000mm) or 98.5"(2500mm) continuous
- Size : Profile w2.36"(60mm) x h1.48"(37.5mm)
- Driver installation : Remote driver required

Custom powder coated colour upon request. Surcharge apply.









Profile sold per metre.

Can be cut to suit any length up to 19' - 8"(6000mm).



**PMMA Diffuser**  
CODE: E60-N (NEW OPAL, LIGHT TRANS. >74%)

### Installing accessories

 <p><b>E60 Aluminium Endcap</b> CODE: E60-CAP CODE: E60-CAP-H</p>	 <p><b>Suspension Kits</b> CODE: SUS.KITSA</p>	 <p><b>Joiners 90°A &amp; B</b> CODE: J-90A &amp; B</p>
 <p><b>E60 CNC Aluminum Cap</b> CODE: E60-CAP-N</p>	 <p><b>Wall Clips</b> CODE: WCLIP-E50</p>	 <p><b>Joiners 120°A &amp; B</b> CODE: J-120A &amp; B</p>
		 <p><b>Joiners 180°A &amp; B</b> CODE: J-180A &amp; B</p>
		 <p><b>Aluminium Diffuser</b> CODE: E60-AD</p>

# Lumi Stick

Architectural Surface & Suspension

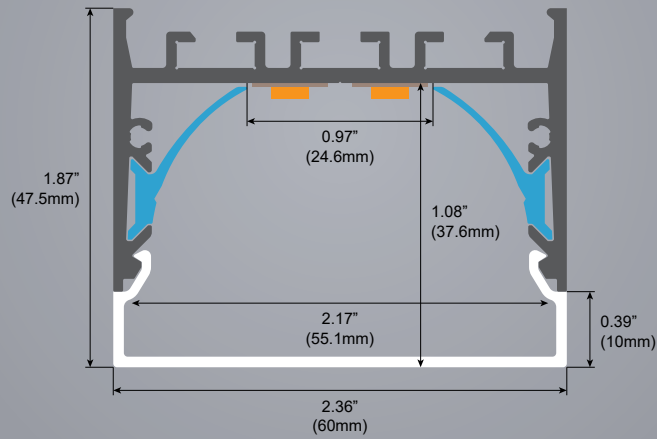

## LS-EU60 Suitable for PCB 45mm

- Max. LED power : 17.6w/ft (57.6w/m)
- Installation : Surface / Suspended
- Material : Extruded Aluminium 6063
- Finish : Silver anodised, Black, White
- Diffuser : PMMA flexible diffuser, can be 82'(25m) continuous rolled
- Length : 78.75"(2000mm) or 98.5"(2500mm) continuous
- Size : Profile w2.36"(60mm) x h1.87"(47.5mm)
- Driver installation : Remote driver required

Custom powder coated colour upon request. Surcharge apply.

Profile sold per metre.

Can be cut to suit any length up to 19' - 8"(6000mm).



**PMMA Diffuser**  
CODE: EU60-O (OPAL, LIGHT TRANS. >60%)

### Installing accessories

<p><b>EU60 Aluminium Endcap</b> CODE: EU60-CAP CODE: EU60-CAP-H</p>	<p><b>Suspension Kits</b> CODE: SUS.KITSA</p>	<p><b>Joiners 90°A &amp; B</b> CODE: J-90A &amp; B</p>
<p><b>EU60 CNC Aluminum Cap</b> CODE: EU60-CAP-N</p>	<p><b>Wall Clips</b> CODE: WCLIP-E50</p>	<p><b>Joiners 120°A &amp; B</b> CODE: J-120A &amp; B</p>
		<p><b>Joiners 180°A &amp; B</b> CODE: J-180A &amp; B</p>



# Lumi Stick

Architectural Surface & Suspension

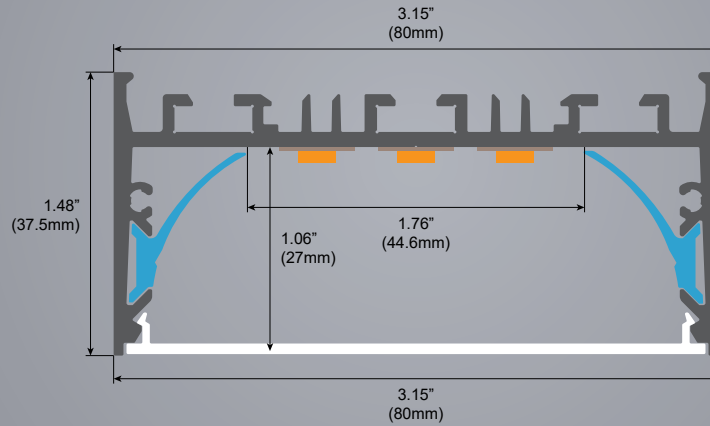

## LS-E80 Suitable for PCB 45mm

- Max. LED power : 17.6w/ft (57.6w/m)
- Installation : Surface / Suspended
- Material : Extruded Aluminium 6063
- Finish : Silver anodised, Black, White
- Diffuser : PMMA flexible diffuser, can be 82'(25m) continuous rolled
- Length : 78.75"(2000mm) or 98.5"(2500mm) continuous
- Size : Profile w3.15"(80mm) x h1.48"(37.5mm)
- Driver installation : Remote driver required

Custom powder coated colour upon request. Surcharge apply.

Profile sold per metre.







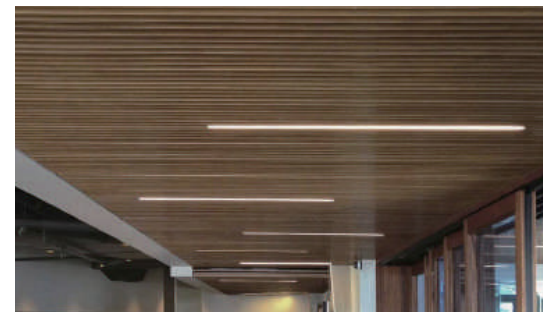

Can be cut to suit any length up to 19' - 8"(6000mm).



**PMMA Diffuser**  
CODE: E80-N (NEW OPAL, LIGHT TRANS. >74%)



### Installing accessories

	<b>E80 Aluminium Endcap</b> CODE: E80-CAP CODE: E80-CAP-H		<b>Suspension Kits</b> CODE: SUS.KITSA		<b>Joiners 90°A &amp; B</b> CODE: J-90A & B
	<b>E80 CNC Aluminum Cap</b> CODE: E80-CAP-N		<b>Wall Clips</b> CODE: WCLIP-E50		<b>Joiners 120°A &amp; B</b> CODE: J-120A & B
					<b>Joiners 180°A &amp; B</b> CODE: J-180A & B
					<b>Aluminium Diffuser</b> CODE: E80-AD

# Lumi Stick

Architectural Surface & Suspension

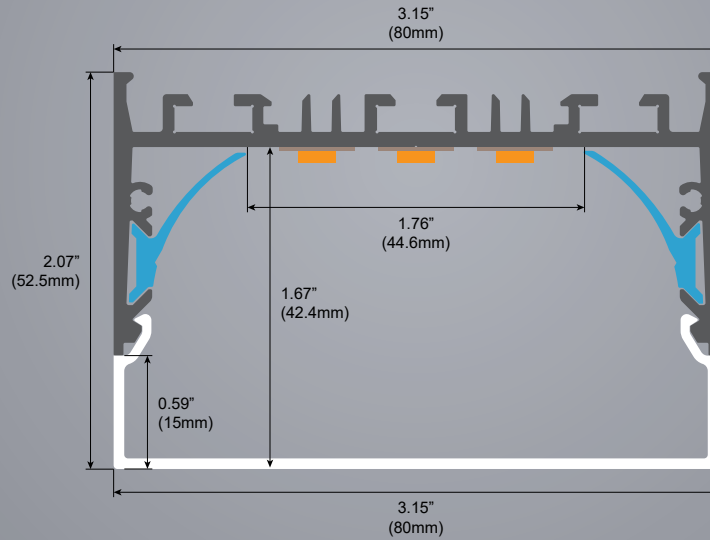

## LS-EU80 Suitable for PCB 25mm

- Max. LED power : 17.6w/ft (57.6w/m)
- Installation : Surface / Suspended
- Material : Extruded Aluminium 6063
- Finish : Silver anodised, Black, White
- Diffuser : PMMA flexible diffuser, can be 82'(25m) continuous rolled
- Length : 78.75"(2000mm) or 98.5"(2500mm) continuous
- Size : Profile w3.15"(80mm) x h2.07"(52.5mm)
- Driver installation : Remote driver required

Custom powder coated colour upon request. Surcharge apply.

Profile sold per metre.

Can be cut to suit any length up to 19' - 8"(6000mm).

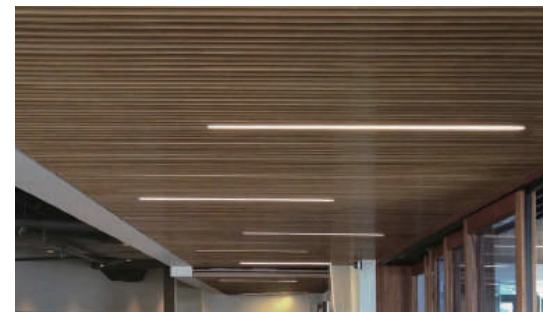

**PMMA Diffuser**  
CODE: EU80-O (OPAL, LIGHT TRANS. >60%)

### Installing accessories



**EU80 Aluminium Endcap**  
CODE: EU80-CAP  
CODE: EU80-CAP-H



**Suspension Kits**  
CODE: SUS.KITSA



**Joiners 90°A & B**  
CODE: J-90A & B



**EU80 CNC Aluminium Cap**  
CODE: EU80-CAP-N



**Wall Clips**  
CODE: WCLIP-E50



**Joiners 120°A & B**  
CODE: J-120A & B



**Joiners 180°A & B**  
CODE: J-180A & B

# Lumi Stick

Architectural Surface & Suspension

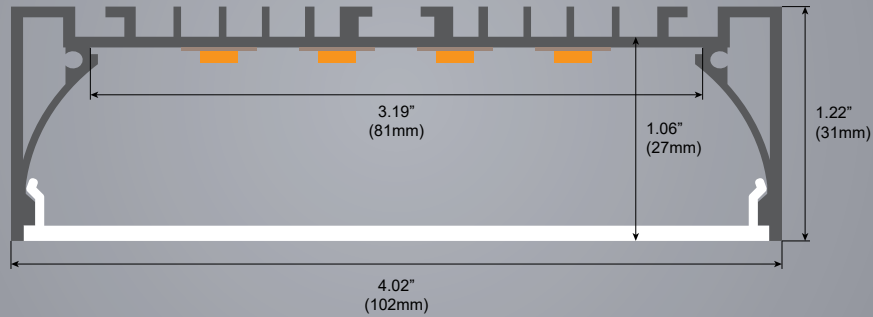

## LS-E100 Suitable for PCB 24mm

- Max. LED power : 17.6w/ft (57.6w/m)
- Installation : Surface / Suspended
- Material : Extruded Aluminium 6063
- Finish : Silver anodised, Black, White
- Diffuser : PMMA flexible diffuser, can be 82'(25m) continuous rolled
- Length : 78.75'(2000mm) or 98.5'(2500mm) continuous
- Size : Profile w4.02"(102mm) x h1.22"(31mm)
- Driver installation : Remote driver required

Custom powder coated colour upon request. Surcharge apply.

Profile sold per metre.

Can be cut to suit any length up to 13' - 1"(4000mm).



**PC Diffuser**  
CODE: E100-O (OPAL, LIGHT TRANS. >55%)

### Installing accessories



**E100 Aluminium Endcap**  
CODE: E100-CAP



**Suspension Kits**  
CODE: SUS.KITSA

# Lumi Stick

Architectural Surface & Suspension

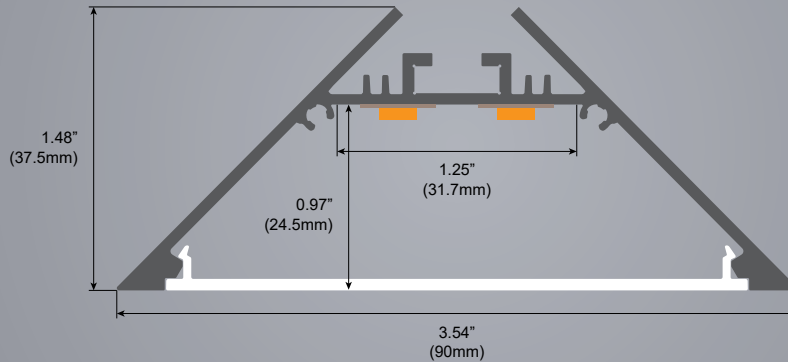

## LS-W91 Suitable for PCB 80mm

- Max. LED power : 17.6w/ft (57.6w/m)
- Installation : Surface / Suspended
- Material : Extruded Aluminium 6063
- Finish : Silver anodised, Black, White
- Diffuser : PMMA flexible diffuser, can be 82'(25m) continuous rolled
- Length : 78.75"(2000mm) or 98.5"(2500mm) continuous
- Size : Profile w3.54"(90mm) x h1.48"(37.5mm)
- Driver installation : Remote driver required

Custom powder coated colour upon request. Surcharge apply.

Profile sold per metre.

Can be cut to suit any length up to 19' - 8"(6000mm).



**PC Diffuser**  
CODE: W91-N (NEW OPAL, LIGHT TRANS. >74%)



### Installing accessories









**W91 Aluminium Endcap**  
CODE: W91-CAP



**Suspension Kits**  
CODE: SUS.KITSA



## Wall

						
<b>Model Number</b>	LS-AW1	LS-AW2	LS-AW4-1	LS-AW8	LS-AW5-1	LS-AW35
<b>Dimension(WxH)</b>	1" x 2.76"	1.09" x 2.76"	0.93" x 3.27"	0.69" x 1.6"	1.38" x 3.27"	1.65" x 1.38"
<b>Max. LED Power</b>	5.9W / ft	4.4W / ft	4.4W / ft	5.9W / ft	5.9W / ft	11.7W / ft
<b>Max. Length</b>	19' - 8"	19' - 8"	19' - 8"	19' - 8"	19' - 8"	19' - 8"
<b>Pages</b>	P. 62	P. 63	P. 64	P. 65	P. 66	P. 67

# Lumi Stick

Wall

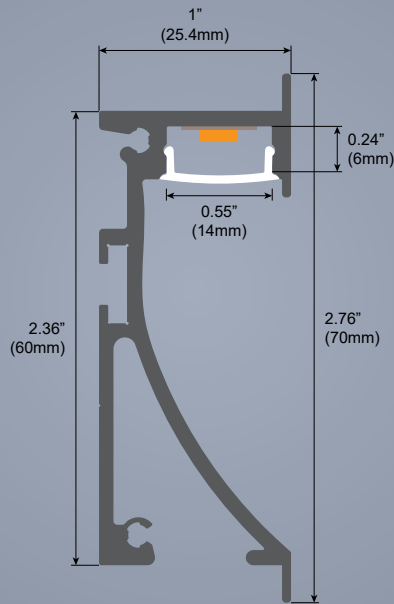

## LS-AW1 Suitable for PCB 12mm

- Max. LED power : 5.9w/ft (19.2w/m)
- Installation : Wall flush
- Material : Extruded Aluminium 6063
- Finish : Silver anodised, Black, White
- Diffuser : PMMA flexible diffuser, can be 82'(25m) continuous rolled
- Length : 78.75'(2000mm) or 98.5'(2500mm) continuous
- Size : Profile w1"(25.4mm) x h2.36"(60mm)
- Driver installation : Remote driver required

Custom powder coated colour upon request. Surcharge apply.

Profile sold per metre.

Can be cut to suit any length up to 19' - 8"(6000mm).

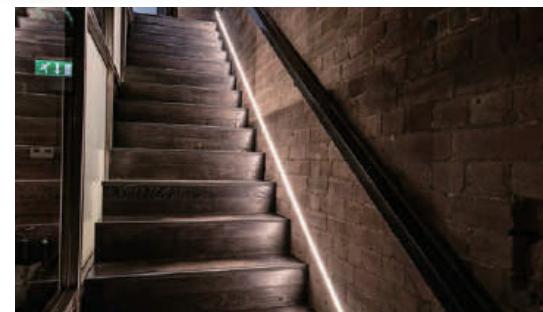
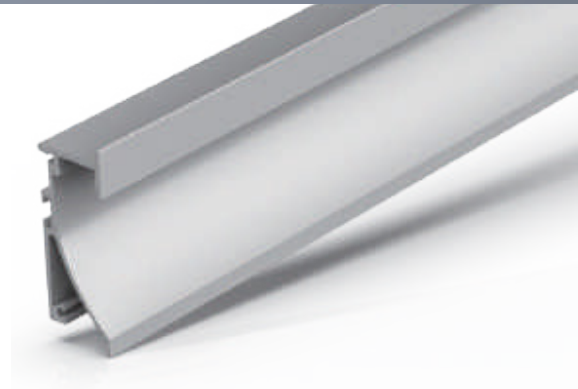

### PMMA Diffuser

CODE: AW1-O (OPAL, LIGHT TRANS. >52%)  
 CODE: AW1-M (MILKY, LIGHT TRANS. >65%)  
 CODE: AW1-F (FROST, LIGHT TRANS. >81%)  
 CODE: AW1-C (CLEAR, LIGHT TRANS. >95%)

### PC Diffuser

CODE: AW1-O (OPAL, LIGHT TRANS. >52%)

## Installing accessories



**AW1  
Aluminium Endcap**  
 CODE: AW1-CAP-L  
 CODE: AW1-CAP-R



**Spring Clip**  
 CODE: SC-AW1



**Metal Clip**  
 CODE: AW1-CLIP-M

# Lumi Stick

Wall

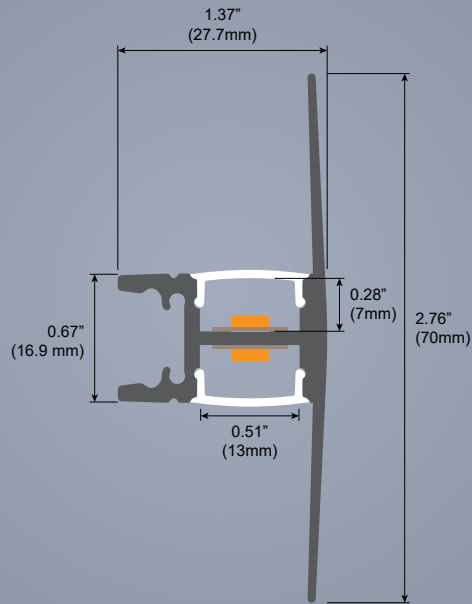

## LS-AW2 Suitable for PCB 12mm

- Max. LED power : 4.4w/ft (14.4w/m)
- Installation : Wall Surface Mounted
- Material : Extruded Aluminium 6063
- Finish : Silver anodised, Black, White
- Diffuser : PMMA flexible diffuser, can be 82'(25m) continuous rolled
- Length : 78.75"(2000mm) or 98.5"(2500mm) continuous
- Size : Profile w1.37"(27.7mm) x h2.76"(70mm)
- Driver installation : Remote driver required

Custom powder coated colour upon request. Surcharge apply.

Profile sold per metre.

Can be cut to suit any length up to 19' - 8"(6000mm).



### PMMA Diffuser

CODE: AW2-O (OPAL, LIGHT TRANS. >52%)  
 CODE: AW2-M (MILKY, LIGHT TRANS. >65%)  
 CODE: AW2-F (FROST, LIGHT TRANS. >81%)  
 CODE: AW2-C (CLEAR, LIGHT TRANS. >95%)

### PC Diffuser

CODE: AW2-O (OPAL, LIGHT TRANS. >52%)

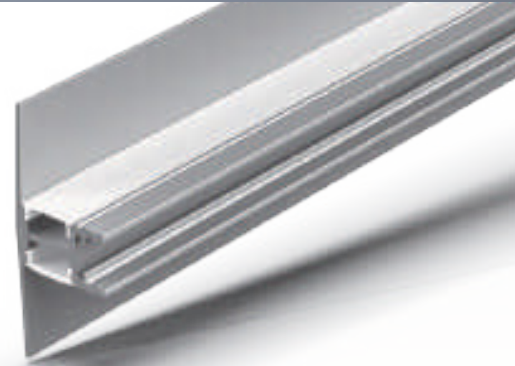

## Installing accessories



**AW2 Aluminium Endcap**  
 CODE: AW2-CAP



**Metal Clip**  
 CODE: AW2-CLIP-M

# Lumi Stick

Wall

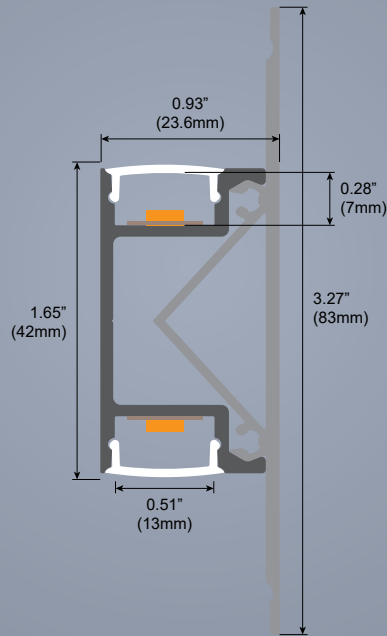

## LS-AW4-1 Suitable for PCB 12mm

- Max. LED power : 4.4w/ft (14.4w/m)
- Installation : Wall Surface Mounted
- Material : Extruded Aluminium 6063
- Finish : Silver anodised, Black, White
- Diffuser : PMMA flexible diffuser, can be 82'(25m) continuous rolled
- Length : 78.75'(2000mm) or 98.5'(2500mm) continuous
- Size : Profile w1"(25.4mm) x h2.36"(60mm)
- Driver installation : Remote driver required

Custom powder coated colour upon request. Surcharge apply.

Profile sold per metre.

Can be cut to suit any length up to 19' - 8"(6000mm).



### PMMA Diffuser

CODE: AW4-1-O (OPAL, LIGHT TRANS. >52%)  
CODE: AW4-1-M (MILKY, LIGHT TRANS. >65%)  
CODE: AW4-1-F (FROST, LIGHT TRANS. >81%)  
CODE: AW4-1-C (CLEAR, LIGHT TRANS. >95%)

### PC Diffuser

CODE: AW4-1-O (OPAL, LIGHT TRANS. >52%)

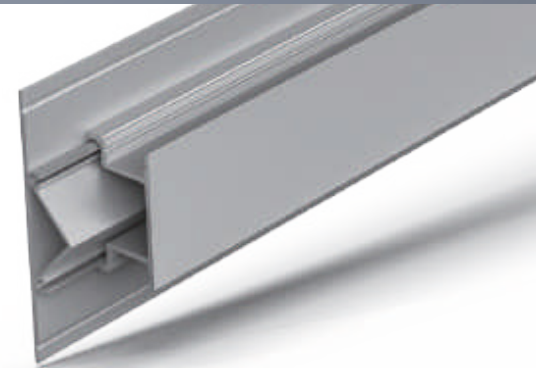

## Installing accessories



**AW4-1**  
Aluminium Endcap  
CODE: AW4-1-CAP



# LumiStick

Wall

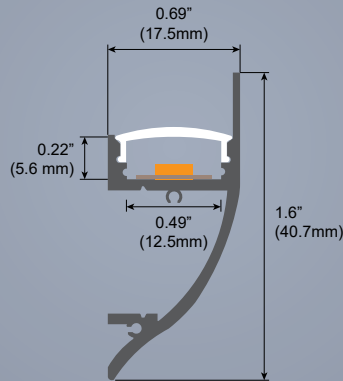

## LS-AW8 Suitable for PCB 12mm

- Max. LED power : 5.9w/ft (19.2w/m)
- Installation : Wall Surface Mounted
- Material : Extruded Aluminium 6063
- Finish : Silver anodised, Black, White
- Diffuser : PMMA flexible diffuser, can be 82'(25m) continuous rolled
- Length : 78.75"(2000mm) or 98.5"(2500mm) continuous
- Size : Profile w0.69"(17.5mm) x h1.6"(40.7mm)
- Driver installation : Remote driver required

Custom powder coated colour upon request. Surcharge apply.

Profile sold per metre.

Can be cut to suit any length up to 13' - 1"(4000mm).



**PC Diffuser**  
CODE: AW8-O (OPAL, LIGHT TRANS. >52%)

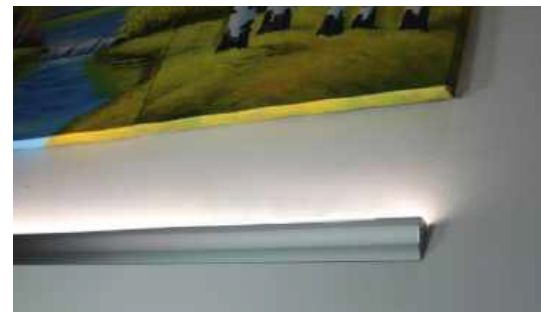

### Installing accessories



**AW8 Aluminium Endcap**  
CODE: AW8-CAP-R  
CODE: AW8-CAP-L



**Metal Clip**  
CODE: AW8-CLIP-M

# Lumi Stick

Wall

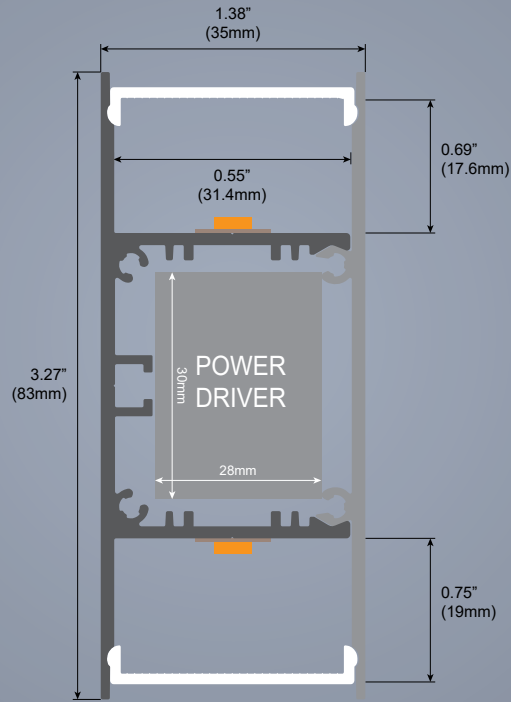

## LS-AW5-1 Suitable for PCB 12mm

- Max. LED power : 5.9w/ft (19.2w/m)
- Installation : Wall Surface Mounted
- Material : Extruded Aluminium 6063
- Finish : Silver anodised, Black, White
- Diffuser : PMMA flexible diffuser, can be 82'(25m) continuous rolled
- Length : 78.75"(2000mm) or 98.5"(2500mm) continuous
- Size : Profile w1.38"(35mm) x h3.27"(83mm)
- Driver installation : Remote driver required

Custom powder coated colour upon request. Surcharge apply.

Profile sold per metre.

Can be cut to suit any length up to 19' - 8"(6000mm).

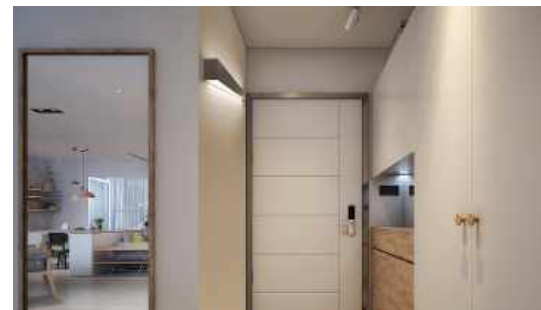
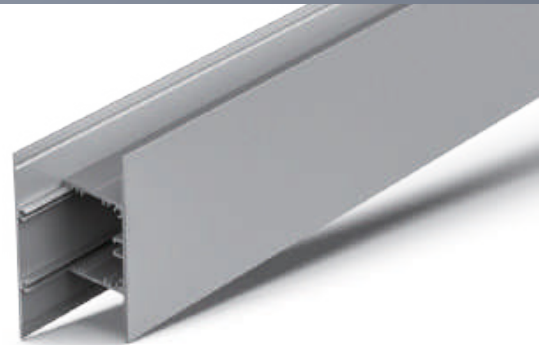

### PMMA Diffuser

CODE: AW5-1-O (OPAL, LIGHT TRANS. >63%)  
 CODE: AW5-1-N (NEW OPAL, LIGHT TRANS. >74%)  
 CODE: AW5-1-F (FROST, LIGHT TRANS. >89%)  
 AW5-1 CODE: AW5-1-C (CLEAR, LIGHT TRANS. >95%)

### Installing accessories



**AW5-1**  
**Aluminium Endcap**  
 CODE: AW5-1-CAP



**Suspension Kits**  
 CODE: SUS.KITSA

# Lumi Stick

Wall

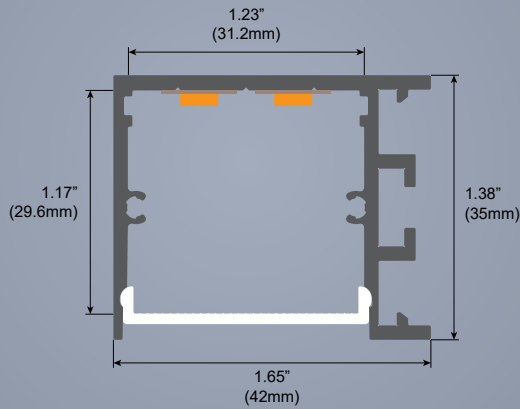

## LS-AW35 Suitable for PCB 30mm

- Max. LED power : 11.7w/ft (38.4w/m)
- Installation : Wall Surface Mounted
- Material : Extruded Aluminium 6063
- Finish : Silver anodised, Black, White
- Diffuser : PMMA flexible diffuser, can be 82'(25m) continuous rolled
- Length : 78.75"(2000mm) or 98.5"(2500mm) continuous
- Size : Profile w1.65"(42mm) x h1.38"(35mm)
- Driver installation : Remote driver required

Custom powder coated colour upon request. Surcharge apply.

Profile sold per metre.

Can be cut to suit any length up to 19' - 8"(6000mm).



### PMMA Diffuser

CODE: AW35-O (OPAL, LIGHT TRANS. >63%)  
 CODE: AW35-N (NEW OPAL, LIGHT TRANS. >74%)  
 CODE: AW35-F (FROST, LIGHT TRANS. >89%)  
 CODE: AW35-C (CLEAR, LIGHT TRANS. >95%)

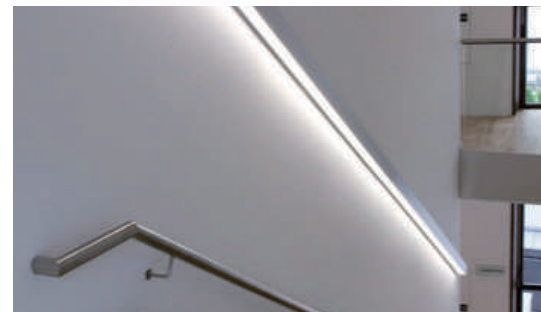

### Installing accessories



**AW35**  
**Screwless Endcap**  
 CODE:AW35-CAP-N



**Metal Clip**  
 CODE:MC-WN35



**Joiners 90°A**  
 CODE: J-90A



**Joiners 90°B**  
 CODE: J-90B



**Joiners 120°A**  
 CODE: J-120A







**Joiners 120°B**  
 CODE: J-120B



**Joiners 180°A**  
 CODE: J-180A



## Architectural Trimless

				
<b>Model Number</b>	LS-TR35	LS-TR50	LS-TR60	LS-TR80
<b>Dimension(WxH)</b>	2.13" x 1.89"	2.64" x 1.89"	2.99" x 1.89"	3.78" x 1.89"
<b>Max. LED Power</b>	8.8W / ft	11.7W / ft	17.6W / ft	17.6W / ft
<b>Max. Length</b>	19' - 8"	19' - 8"	19' - 8"	19' - 8"
<b>Pages</b>	P. 69	P. 70	P. 71	P. 72

# Lumi Stick

Architectural Trimless

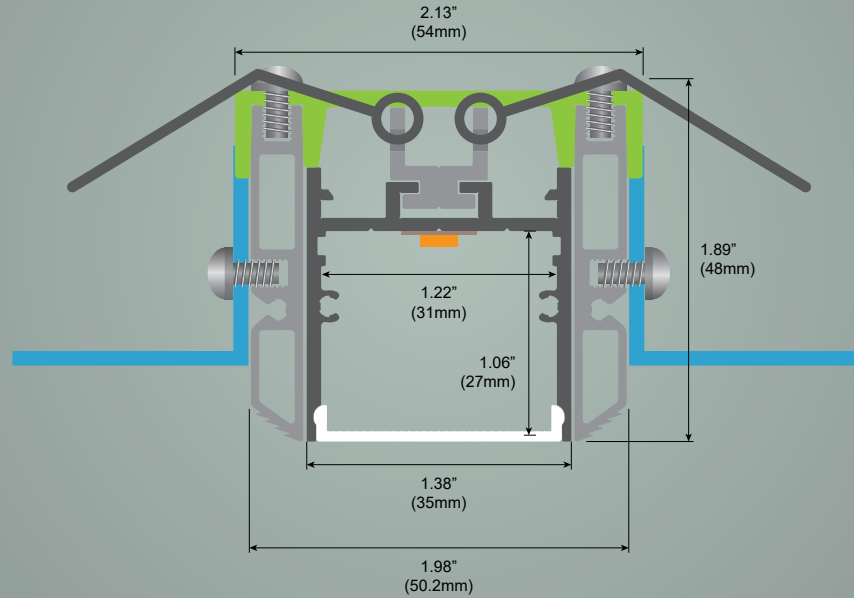

## LS-TR35 Suitable for PCB 30mm

- Max. LED power : 8.8w/ft (28.8w/m)
- Installation : Ceiling Trimless
- Material : Extruded Aluminium 6063
- Finish : Silver anodised, Black, White
- Diffuser : PMMA flexible diffuser, can be 82'(25m) continuous rolled
- Length : 78.75'(2000mm) or 98.5'(2500mm) continuous
- Size : Profile w2.13"(54mm) x h1.89"(48mm)
- Driver installation : Remote driver required

Custom powder coated colour upon request. Surcharge apply.

Profile sold per metre.



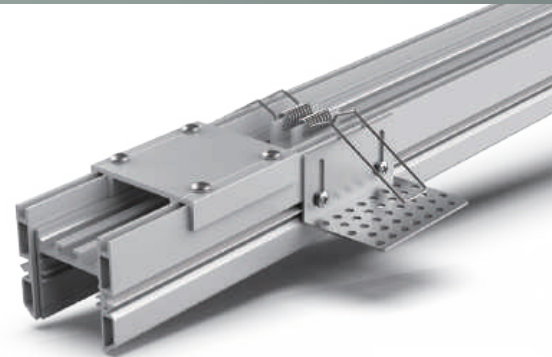





Can be cut to suit any length up to 19' - 8"(6000mm).



### PMMA Diffuser

CODE: TR35-O (OPAL, LIGHT TRANS. >63%)  
 CODE: TR35-N (NEW OPAL, LIGHT TRANS. >74%)  
 CODE: TR35-F (FROST, LIGHT TRANS. >89%)  
 CODE: TR35-C (CLEAR, LIGHT TRANS. >95%)

### Installing accessories

	<b>TR35 Aluminium Endcap</b> CODE: TR35-CAP		<b>L Bracket</b> CODE: LW-LMB		<b>Joiners 90°A</b> CODE: J-90A
	<b>TR35 Aluminium Endcap</b> CODE: TR35-CAP		<b>Aluminium Bridge</b> CODE: LW-TR35		<b>Joiners 120°A</b> CODE: J-120A
			<b>Spring Clip</b> CODE: SC-WN31		<b>Joiners 180°A</b> CODE: J-180A

# Lumi Stick

Architectural Trimless

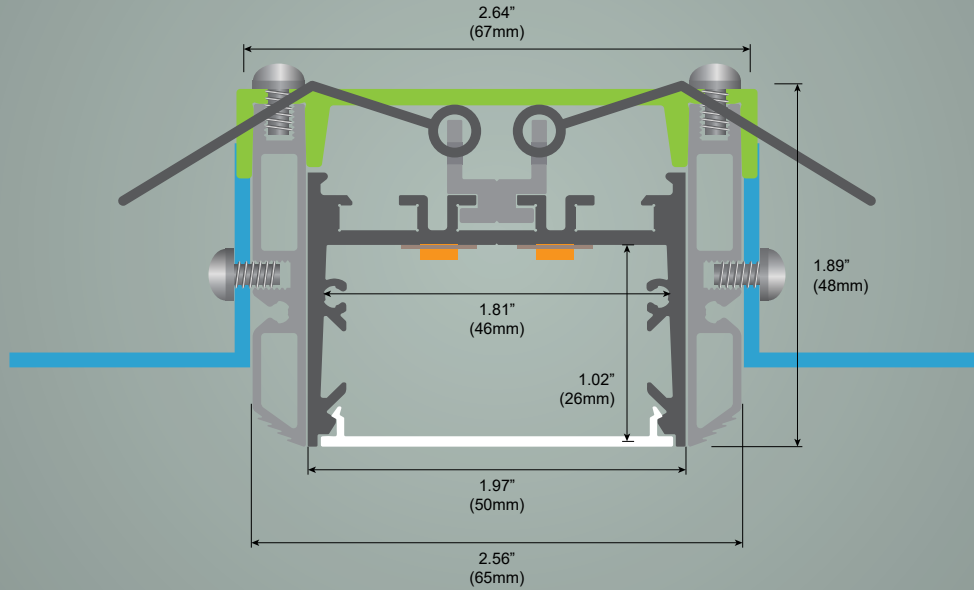

## LS-TR50 Suitable for PCB 45mm

- Max. LED power : 11.7w/ft (38.4w/m)
- Installation : Ceiling Trimless
- Material : Extruded Aluminium 6063
- Finish : Silver anodised, Black, White
- Diffuser : PMMA flexible diffuser, can be 82"(25m) continuous rolled
- Length : 78.75"(2000mm) or 98.5"(2500mm) continuous
- Size : Profile w2.64"(67mm) x h1.89"(48mm)
- Driver installation : Remote driver required

Custom powder coated colour upon request. Surcharge apply.

Profile sold per metre.



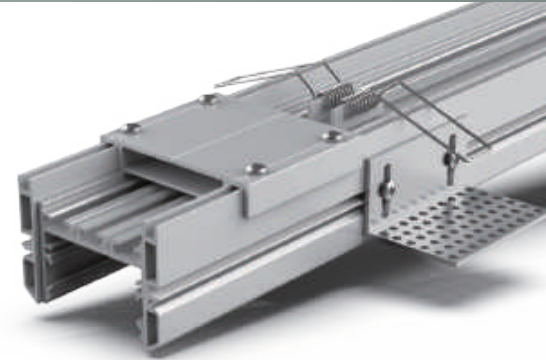





Can be cut to suit any length up to 19' - 8"(6000mm).



### PMMA Diffuser

CODE: TR50-O (OPAL, LIGHT TRANS. >60%)  
TR50 CODE: TR50-N (NEW OPAL, LIGHT TRANS. >77%)

### Installing accessories

	<b>TR50 Aluminium Endcap</b> CODE: TR50-CAP		<b>L Bracket</b> CODE: LW-LMB		<b>Joiners 90°A</b> CODE: J-90A
	<b>TR50 Aluminium Endcap</b> CODE: TR50-CAP		<b>Aluminium Bridge</b> CODE: LW-TR50		<b>Joiners 120°A</b> CODE: J-120A
	<b>Spring Clip</b> CODE: SC-WN31		<b>Joiners 180°A &amp; B</b> CODE: J-180A & B		

# Lumi Stick

Architectural Trimless

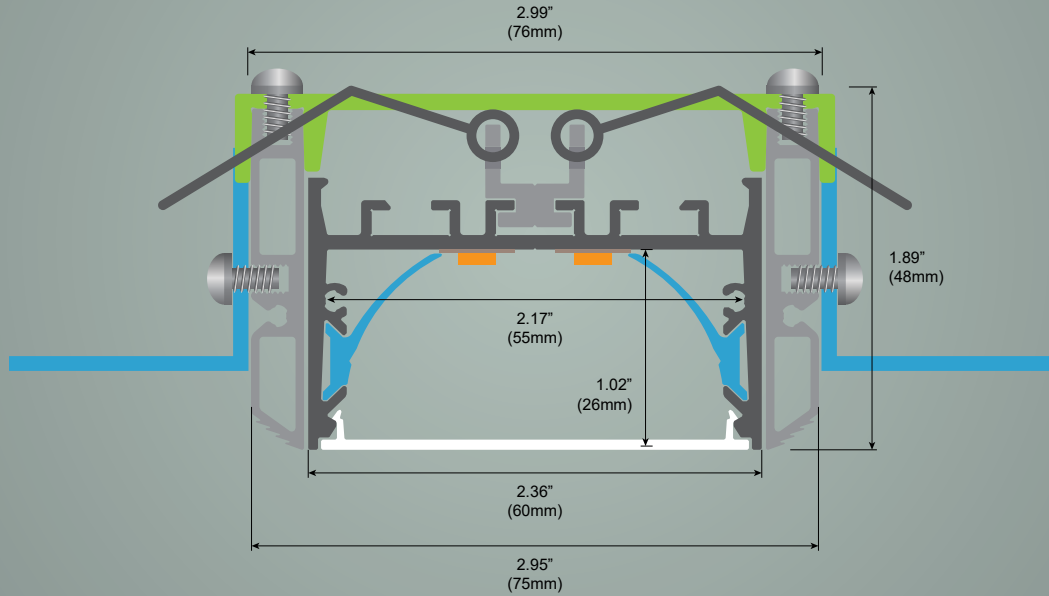

## LS-TR50 Suitable for PCB 55mm

- Max. LED power : 17.6w/ft (57.6w/m)
- Installation : Ceiling Trimless
- Material : Extruded Aluminium 6063
- Finish : Silver anodised, Black, White
- Diffuser : PMMA flexible diffuser, can be 82'(25m) continuous rolled
- Length : 78.75'(2000mm) or 98.5'(2500mm) continuous
- Size : Profile w2.99"(76mm) x h1.89"(48mm)
- Driver installation : Remote driver required

Custom powder coated colour upon request. Surcharge apply.

Profile sold per metre.

Can be cut to suit any length up to 19' - 8"(6000mm).

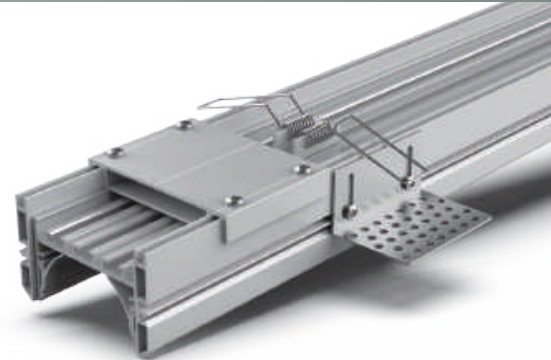

**PMMA Diffuser**  
CODE: TR60-N (NEW OPAL, LIGHT TRANS. >74%)

### Installing accessories

	<b>TR60 Aluminium Endcap</b> CODE: TR60-CAP		<b>L Bracket</b> CODE: LW-LMB		<b>Joiners 90°A</b> CODE: J-90A
	<b>TR60 Aluminium Endcap</b> CODE: TR60-CAP		<b>Aluminium Bridge</b> CODE: LW-TR60		<b>Joiners 120°A</b> CODE: J-120A
		<b>Spring Clip</b> CODE: SC-WN31		<b>Joiners 180°A &amp; B</b> CODE: J-180A & B	

# Lumi Stick

Architectural Trimless

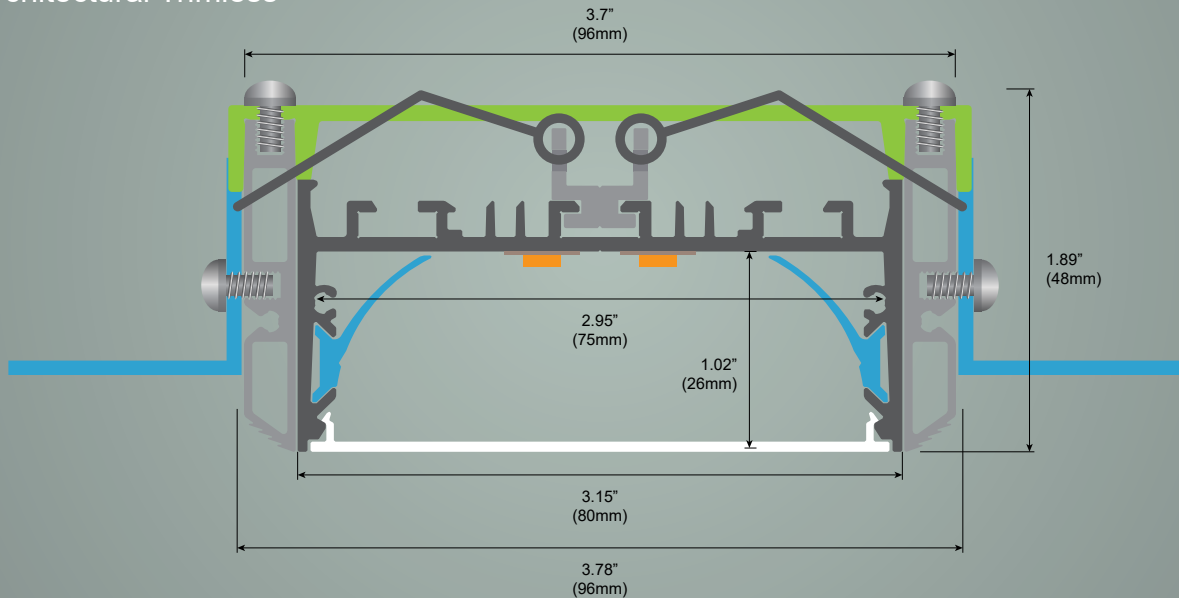

## LS-TR80 Suitable for PCB 75mm

- Max. LED power : 17.6w/ft (57.6w/m)
- Installation : Ceiling Trimless
- Material : Extruded Aluminium 6063
- Finish : Silver anodised, Black, White
- Diffuser : PMMA flexible diffuser, can be 82'(25m) continuous rolled
- Length : 78.75'(2000mm) or 98.5'(2500mm) continuous
- Size : Profile w3.7"(96mm) x h1.89"(48mm)
- Driver installation : Remote driver required

Custom powder coated colour upon request. Surcharge apply.

Profile sold per metre.

Can be cut to suit any length up to 19' - 8"(6000mm).

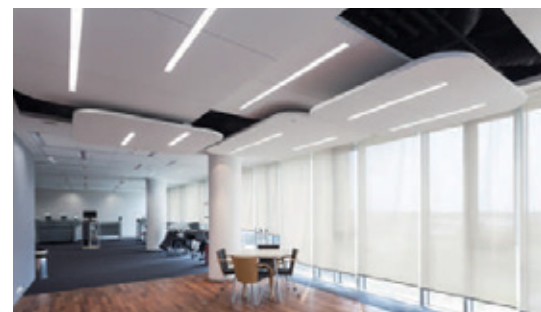
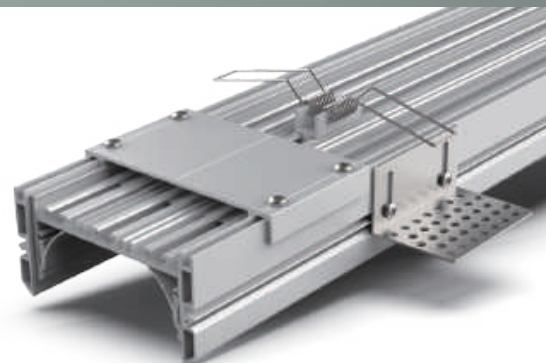

**PMMA Diffuser**  
CODE: TR80-N (NEW OPAL, LIGHT TRANS. >74%)





### Installing accessories

	<b>TR80 Aluminium Endcap</b> CODE: TR80-CAP		<b>L Bracket</b> CODE: LW-LMB		<b>Joiners 90°A</b> CODE: J-90A
	<b>TR80 Aluminium Endcap</b> CODE: TR80-CAP		<b>Aluminium Bridge</b> CODE: LW-TR80		<b>Joiners 120°A</b> CODE: J-120A
			<b>Spring Clip</b> CODE: SC-WN31		<b>Joiners 180°A &amp; B</b> CODE: J-180A & B





## Architectural Recessed

						
<b>Model Number</b>	LS-WN31	LS-ER50	LS-ER60	LS-ER50-2	LS-ER7635	LS-AW1-50
<b>Dimension(WxH)</b>	1.93" x 1.48"	2.52" x 1.77"	2.91" x 1.77"	3.15" x 0.98"	3.58" x 1.38"	0.77" x 1.97"
<b>Max. LED Power</b>	11.7W / ft	17.6W / ft	17.6W / ft	11.7W / ft	17.6W / ft	5.9W / ft
<b>Max. Length</b>	19' - 8"	16' - 4"	16' - 4"	19' - 8"	13' - 1"	19' - 8"
<b>Pages</b>	P. 74	P. 75	P. 76	P. 77	P. 78	P. 79

# Lumi Stick

Architectural Recessed

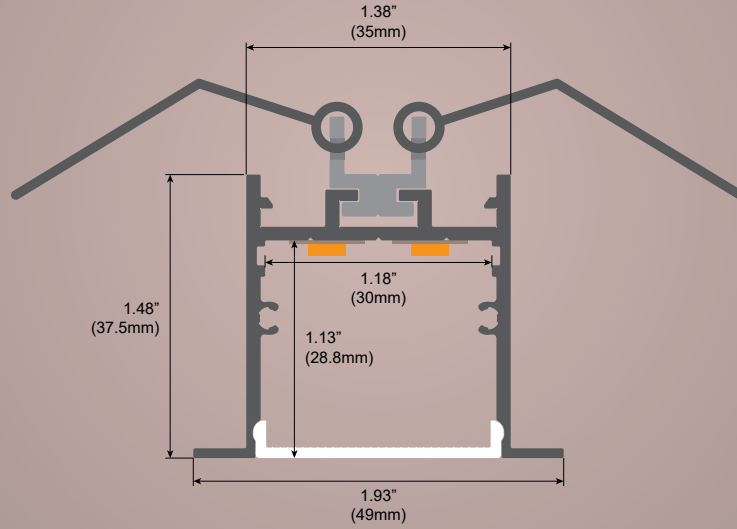

## LS-WN31 Suitable for PCB 30mm

- Max. LED power : 11.7w/ft (38.4w/m)
- Installation : Recessed
- Material : Extruded Aluminium 6063
- Finish : Silver anodised, Black, White
- Diffuser : PMMA flexible diffuser, can be 82'(25m) continuous rolled
- Length : 78.75"(2000mm) or 98.5'(2500mm) continuous
- Size : Profile w1.93"(49mm) x h1.48"(37.5mm)
- Driver installation : Remote driver required

Custom powder coated colour upon request. Surcharge apply.

Profile sold per metre.

Can be cut to suit any length up to 19' - 8"(6000mm).



### PMMA Diffuser

CODE: WN31-O (OPAL, LIGHT TRANS. >63%)  
 CODE: WN31-N (NEW OPAL, LIGHT TRANS. >74%)  
 CODE: WN31-F (FROST, LIGHT TRANS. >89%)  
 CODE: WN31-C (CLEAR, LIGHT TRANS. >95%)



### Black Diffuser

CODE: WN31-B (BLACK, LIGHT TRANS. >22%)  
 MOQ: 200M

### Installing accessories



**WN31 Screwless Endcap**  
 CODE: WN31-CAP  
 CODE: WN31-CAP-H



**Spring Clip**  
 CODE: SC-WN31



**Joiners 90°A**  
 CODE: J-90A



**Joiners 120°A**  
 CODE: J-120A



**Joiners 180°A**  
 JOINERS 180°A

# Lumi Stick

Architectural Recessed

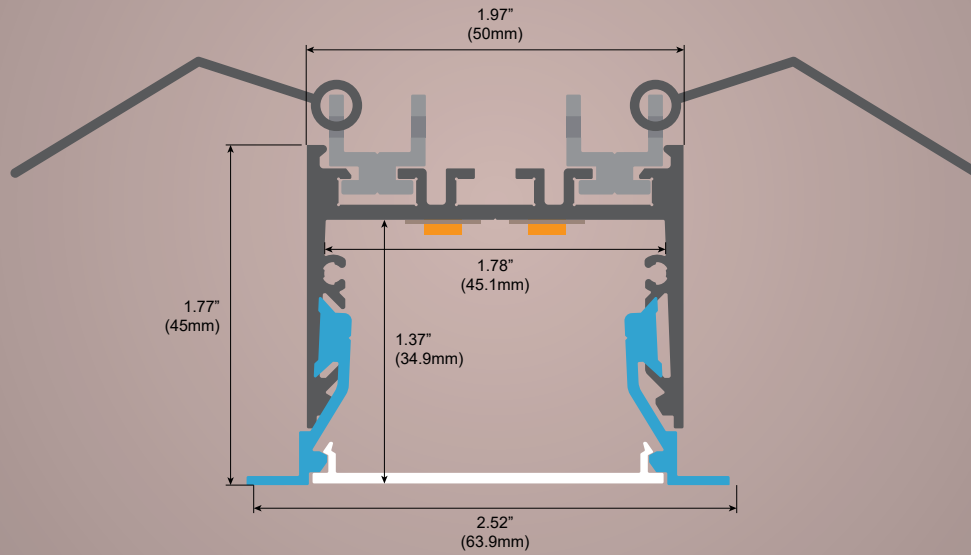

## LS-ER50 Suitable for PCB 45mm

- Max. LED power : 17.6w/ft (57.6w/m)
- Installation : Recessed
- Material : Extruded Aluminium 6063
- Finish : Silver anodised, Black, White
- Diffuser : PMMA flexible diffuser, can be 82'(25m) continuous rolled
- Length : 78.75"(2000mm) or 98.5"(2500mm) continuous
- Size : Profile w2.52"(63.9mm) x h1.77"(45mm)
- Driver installation : Remote driver required

Custom powder coated colour upon request. Surcharge apply.

Profile sold per metre.

Can be cut to suit any length up to 19' - 8"(6000mm).



### PMMA Diffuser

CODE: ER50-O (OPAL, LIGHT TRANS. >60%)  
CODE: ER50-N (NEW OPAL, LIGHT TRANS. >74%)



### Installing accessories



**ER50**  
**Screwless Endcap**  
CODE: ER50-CAP  
CODE: ER50-CAP-H



**Spring Clip**  
CODE: SC-ER50



**Joiners 90°A**  
CODE: J-90A



**Joiners 120°A**  
CODE: J-120A



**Joiners 180°A**  
JOINERS 180°A

# Lumi Stick

## Architectural Recessed

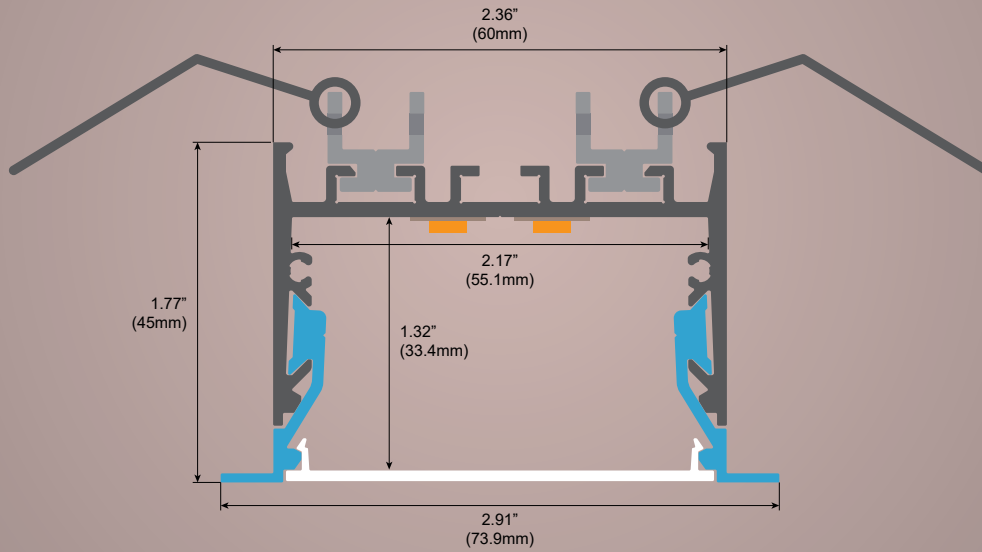

## LS-ER60 Suitable for PCB 38mm

- Max. LED power : 17.6w/ft (57.6w/m)
- Installation : Recessed
- Material : Extruded Aluminium 6063
- Finish : Silver anodised, Black, White
- Diffuser : PMMA flexible diffuser, can be 82'(25m) continuous rolled
- Length : 78.75"(2000mm) or 98.5"(2500mm) continuous
- Size : Profile w2.52"(63.9mm) x h1.77"(45mm)
- Driver installation : Remote driver required

Custom powder coated colour upon request. Surcharge apply.

Profile sold per metre.

Can be cut to suit any length up to 16' - 4"(5000mm).



**PMMA Diffuser**  
CODE: ER60-N (NEW OPAL, LIGHT TRANS. >74%)



### Installing accessories



**ER60  
Screwless Endcap**  
CODE: ER60-CAP  
CODE: ER60-CAP-H



**Spring Clip**  
CODE: SC-ER50



**Joiners 90°A & B**  
CODE: J-90A & B



**Joiners 120°A & B**  
CODE: J-120A & B



**Joiners 180°A**  
JOINERS 180°A

# Lumi Stick

Architectural Recessed

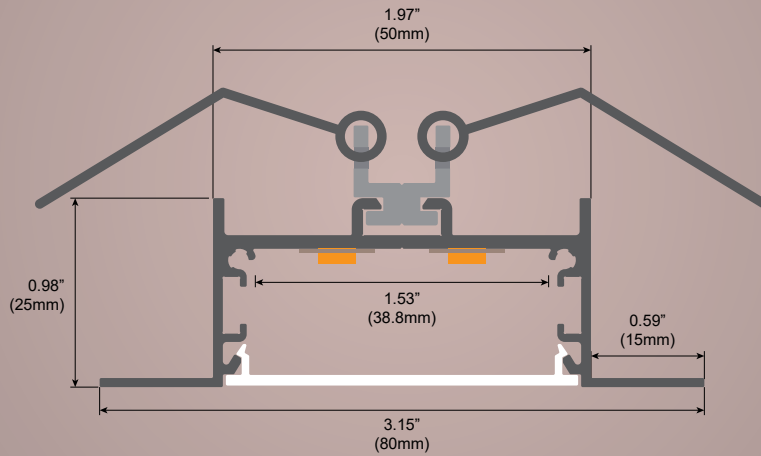

## LS-ER50-2 Suitable for PCB 50mm

- Max. LED power : 11.7w/ft (38.4w/m)
- Installation : Recessed
- Material : Extruded Aluminium 6063
- Finish : Silver anodised, Black, White
- Diffuser : PMMA flexible diffuser, can be 82'(25m) continuous rolled
- Length : 78.75"(2000mm) or 98.5"(2500mm) continuous
- Size : Profile w3.15"(80mm) x h0.98"(25mm)
- Driver installation : Remote driver required

Custom powder coated colour upon request. Surcharge apply.

Profile sold per metre.

Can be cut to suit any length up to 19' - 8"(6000mm).

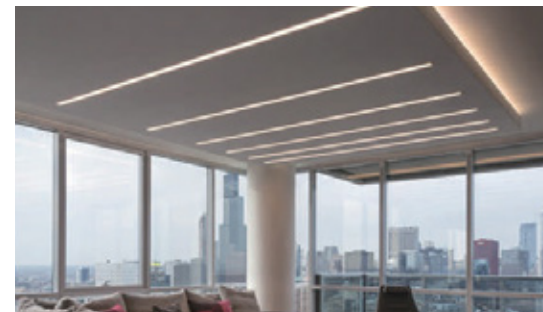

### PMMA Diffuser

CODE: ER50-2-O (OPAL, LIGHT TRANS. >60%)  
CODE: ER50-2-N (NEW OPAL, LIGHT TRANS. >74%)

### Installing accessories



**ER50-2**  
Aluminium Endcap  
CODE: ER60-CAP  
CODE: ER60-CAP-H



**Spring Clip**  
CODE: SC-WN31



**Joiners 90°A**  
CODE: J-90A



**Joiners 120°A**  
CODE: J-120A



**Joiners 180°A**  
CODE: J-180A

# Lumi Stick

Architectural Recessed

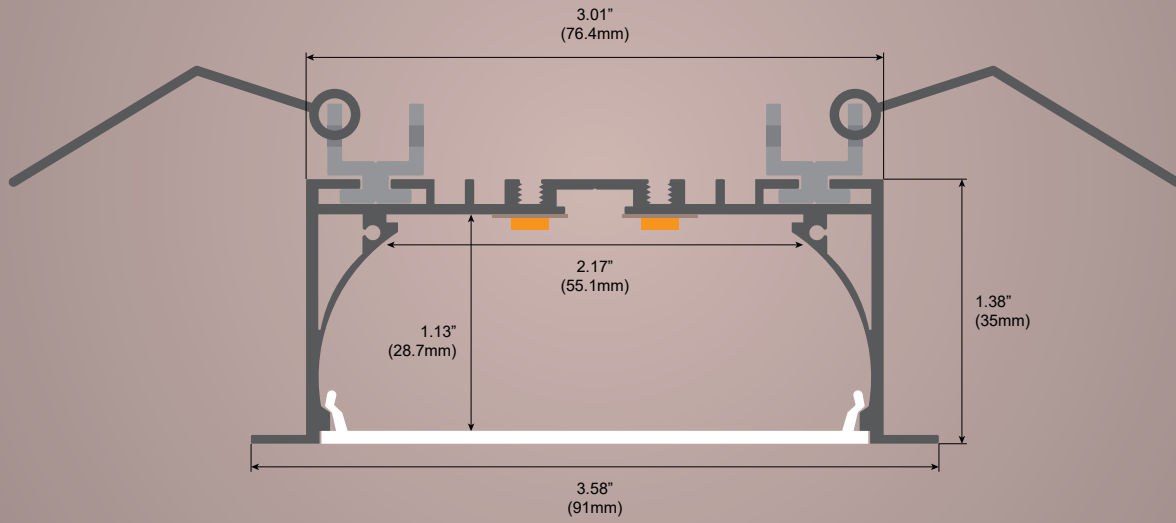

## LS-ER7635 Suitable for PCB 55mm

- Max. LED power : 17.6w/ft (57.6w/m)
- Installation : Recessed
- Material : Extruded Aluminium 6063
- Finish : Silver anodised, Black, White
- Diffuser : PMMA flexible diffuser, can be 82'(25m) continuous rolled
- Length : 78.75"(2000mm) or 98.5"(2500mm) continuous
- Size : Profile w3.58"(91mm) x h1.38"(35mm)
- Driver installation : Remote driver required

Custom powder coated colour upon request. Surcharge apply.

Profile sold per metre.

Can be cut to suit any length up to 19' - 8"(6000mm).



**PC Diffuser**  
CODE: ER7635-O (OPAL, LIGHT TRANS. >55%)

### Installing accessories



**ER7635**  
**Aluminium Endcap**  
CODE: ER7635-CAP



**Spring Clip**  
CODE: SC-ER7635

# Lumi Stick

Architectural Recessed

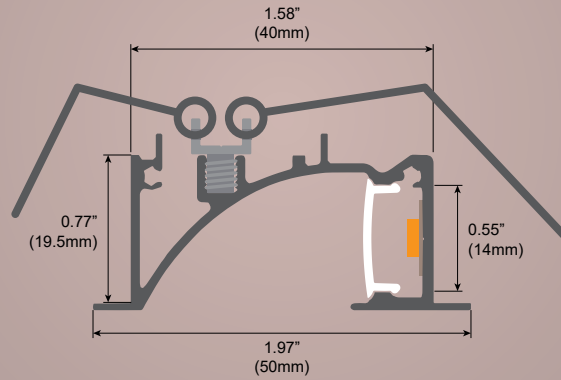

## LS-AW1-50 Suitable for PCB 14mm

- Max. LED power : 5.9w/ft (19.2w/m)
- Installation : Wall Flush
- Material : Extruded Aluminium 6063
- Finish : Silver anodised, Black, White
- Diffuser : PMMA flexible diffuser, can be 82'(25m) continuous rolled
- Length : 78.75"(2000mm) or 98.5"(2500mm) continuous
- Size : Profile w0.77"(19.5mm) x h1.97"(50mm)
- Driver installation : Remote driver required

Custom powder coated colour upon request. Surcharge apply.

Profile sold per metre.

Can be cut to suit any length up to 19' - 8"(6000mm).



### PMMA Diffuser

CODE: AW1-50-O (OPAL, LIGHT TRANS. >52%)  
 CODE: AW1-50-M (MILKY, LIGHT TRANS. >65%)  
 CODE: AW1-50-F (FROST, LIGHT TRANS. >81%)  
 CODE: AW1-50-C (CLEAR, LIGHT TRAANS. >95%)

### PC Diffuser

CODE: AW1-50-O (OPAL, LIGHT TRANS. >52%)

## Installing accessories



**AW1-50**  
**Aluminium Endcap**  
 CODE: AW1-50-CAP



**Spring Clip**  
 CODE: SC-N31-4



## Plaster in Trimless

							
<b>Model Number</b>	LS-CT4N	LS-CT5	LS-CT5S	LS-CT6	LS-CT7	LS-CT8	LS-AT7N
<b>Dimension(WxH)</b>	2.61" x 0.65"	2.32" x 0.54"	1.53" x 0.54"	1.96" x 1.03"	2.19" x 0.93"	1.67" x 1.22"	2.19" x 1.76"
<b>Max. LED Power</b>	5.9W / ft	5.9W / ft	5.9W / ft	5.9W / ft	5.9W / ft	5.9W / ft	5.9W / ft
<b>Max. Length</b>	8' - 2"	8' - 2"	8' - 2"	8' - 2"	8' - 2"	8' - 2"	19' - 8"
<b>Pages</b>	P. 81	P. 82	P. 83	P. 84	P. 85	P. 86	P. 87



# Lumi Stick

Plaster in Trimless

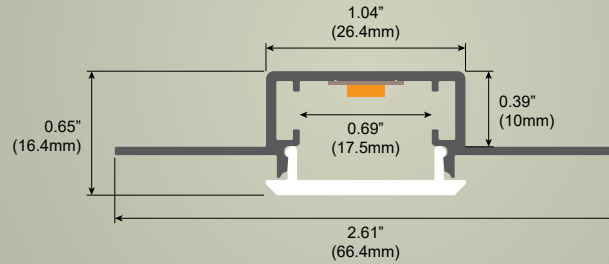

## LS-CT4N Suitable for PCB 16mm

- Max. LED power : 5.9w/ft (19.2w/m)
- Installation : Plaster in Trimless
- Material : Extruded Aluminium 6063
- Finish : Silver anodised
- Diffuser : PMMA flexible diffuser, can be 82'(25m) continuous rolled
- Length : 78.75"(2000mm) or 98.5"(2500mm) continuous
- Size : Profile w2.61"(66.4mm) x h0.65"(16.4mm)
- Driver installation : Remote driver required

Custom powder coated colour upon request. Surcharge apply.

Profile sold per metre.

Can be cut to suit any length up to 8' - 2"(2500mm).



**PMMA Diffuser**  
CODE: CT4N-O (OPAL, LIGHT TRANS. >52%)

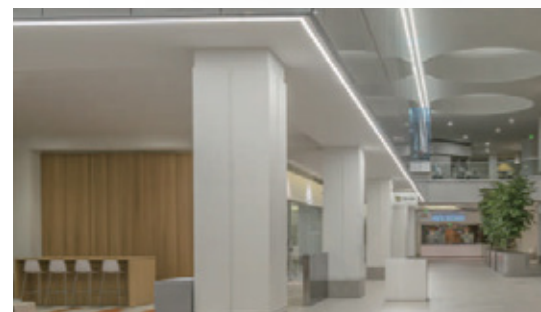

### Installing accessories



**CT4N  
Plastic Endcap**  
CODE: CT4N-CAP  
CODE: CT4N-CAP-H



**Joiners 90°A & B**  
CODE: J-90A & B



**Joiners 120°A & B**  
CODE: J-120A & B



**Joiners 180°A**  
JOINERS 180°A

# Lumi Stick

Plaster in Trimless

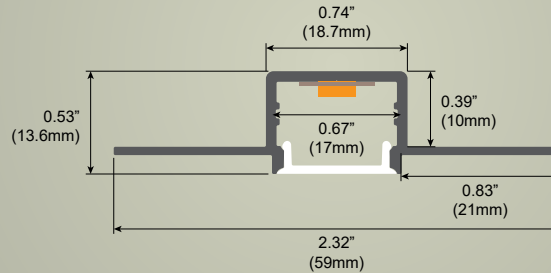

## LS-CT5 Suitable for PCB 16mm

- Max. LED power : 5.9w/ft (19.2w/m)
- Installation : Plaster in Trimless
- Material : Extruded Aluminium 6063
- Finish : Silver anodised
- Diffuser : PMMA flexible diffuser, can be 82'(25m) continuous rolled
- Length : 78.75"(2000mm) or 98.5"(2500mm) continuous
- Size : Profile w2.32"(59mm) x h0.53"(13.6mm)
- Driver installation : Remote driver required

Custom powder coated colour upon request. Surcharge apply.

Profile sold per metre.

Can be cut to suit any length up to 8' - 2"(2500mm).

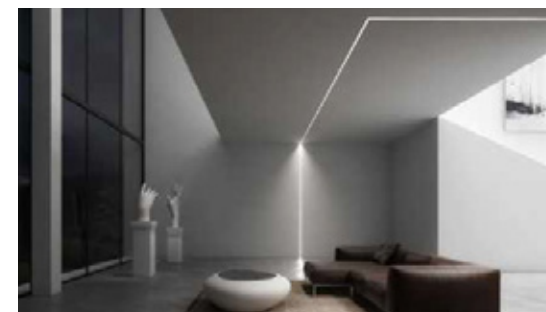

**PMMA Diffuser**

CODE: CT5-O (OPAL, LIGHT TRANS. >52%)



**Black Diffuser**

CODE:CT5-B (BLACK, LIGHT TRANS.>22%)  
MOQ:200M

### Installing accessories



**CT5**

**Plastic Endcap**

CODE: CT5-CAP  
CODE: CT5-CAP-H

# Lumi Stick

Plaster in Trimless

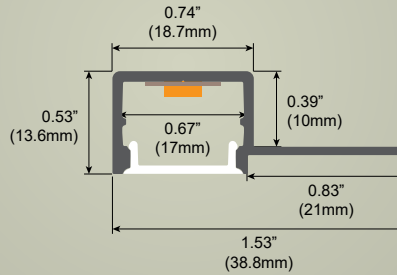

## LS-CT5S Suitable for PCB 16mm

- Max. LED power : 5.9w/ft (19.2w/m)
- Installation : Plaster in Trimless
- Material : Extruded Aluminium 6063
- Finish : Silver anodised
- Diffuser : PMMA flexible diffuser, can be 82'(25m) continuous rolled
- Length : 78.75"(2000mm) or 98.5"(2500mm) continuous
- Size : Profile w1.53"(38.8mm) x h0.53"(13.6mm)
- Driver installation : Remote driver required

Custom powder coated colour upon request. Surcharge apply.

Profile sold per metre.

Can be cut to suit any length up to 8' - 2"(2500mm).



**PMMA Diffuser**  
CODE: CT5S-O (OPAL, LIGHT TRANS. >52%)



**Black Diffuser**  
CODE:CT5-B (BLACK, LIGHT TRANS.>22%)  
MOQ:200M

### Installing accessories



**CT5 Plastic Endcap**  
CODE: CT5-CAP  
CODE: CT5-CAP-H

# Lumi Stick

Plaster in Trimless

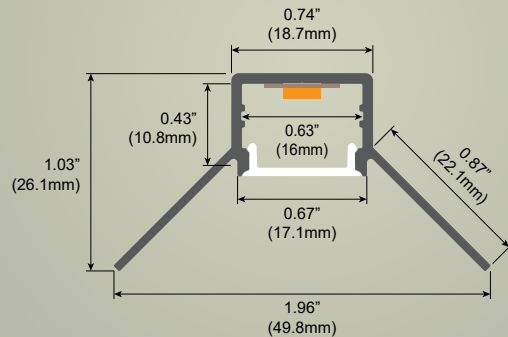

## LS-CT6 Suitable for PCB 16mm

- Max. LED power : 5.9w/ft (19.2w/m)
- Installation : Plaster in Trimless
- Material : Extruded Aluminium 6063
- Finish : Silver anodised
- Diffuser : PMMA flexible diffuser, can be 82'(25m) continuous rolled
- Length : 78.75"(2000mm) or 98.5"(2500mm) continuous
- Size : Profile w1.96"(49.8mm) x h1.03"(26.1mm)
- Driver installation : Remote driver required

Custom powder coated colour upon request. Surcharge apply.

Profile sold per metre.

Can be cut to suit any length up to 8' - 2"(2500mm).



**PMMA Diffuser**  
CODE: CT6-O (OPAL, LIGHT TRANS. >52%)



**Black Diffuser**  
CODE: CT6-B (BLACK, LIGHT TRANS. >22%)  
MOQ: 200M

### Installing accessories



**CT5  
Plastic Endcap**  
CODE: CT5-CAP  
CODE: CT5-CAP-H

# Lumi Stick

Plaster in Trimless

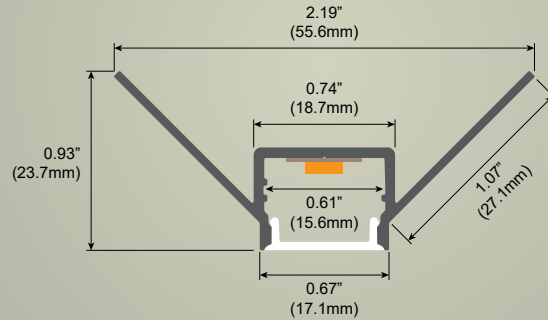

## LS-CT7 Suitable for PCB 16mm

- Max. LED power : 5.9w/ft (19.2w/m)
- Installation : Plaster in Trimless, Doutside corner
- Material : Extruded Aluminium 6063
- Finish : Silver anodised
- Diffuser : PMMA flexible diffuser, can be 82'(25m) continuous rolled
- Length : 78.75"(2000mm) or 98.5"(2500mm) continuous
- Size : Profile w2.19"(56.6mm) x h0.93"(23.7mm)
- Driver installation : Remote driver required

Custom powder coated colour upon request. Surcharge apply.

Profile sold per metre.

Can be cut to suit any length up to 8' - 2"(2500mm).

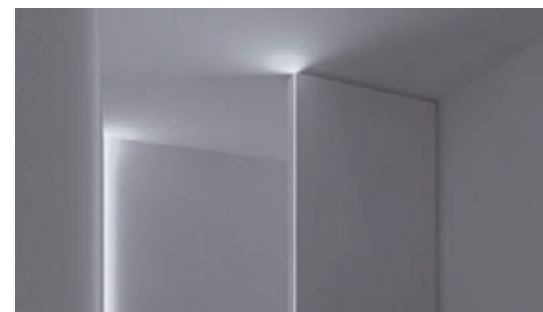

**PMMA Diffuser**  
CODE: CT7-O (OPAL, LIGHT TRANS. >52%)



**Black Diffuser**  
CODE: CT5-B (BLACK, LIGHT TRANS. >22%)  
MOQ: 200M

### Installing accessories



**CT5  
Plastic Endcap**  
CODE: CT5-CAP  
CODE: CT5-CAP-H

# Lumi Stick

Plaster in Trimless

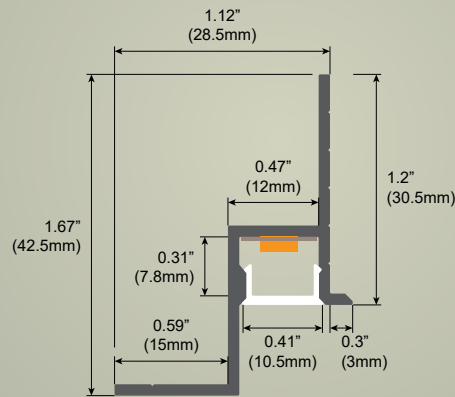

## LS-CT8 Suitable for PCB 10mm

- Max. LED power : 5.9w/ft (19.2w/m)
- Installation : Plaster in Trimless
- Material : Extruded Aluminium 6063
- Finish : Silver anodised
- Diffuser : PMMA flexible diffuser, can be 82'(25m) continuous rolled
- Length : 78.75'(2000mm) or 98.5'(2500mm) continuous
- Size : Profile w1.67"(42.5mm) x h1.12"(28.5mm)
- Driver installation : Remote driver required

Custom powder coated colour upon request. Surcharge apply.

Profile sold per metre.

Can be cut to suit any length up to 8' - 2"(2500mm).



**PMMA Diffuser**  
CODE: CT8-O (OPAL, LIGHT TRANS. >52%)



# Lumi Stick

Plaster in Trimless

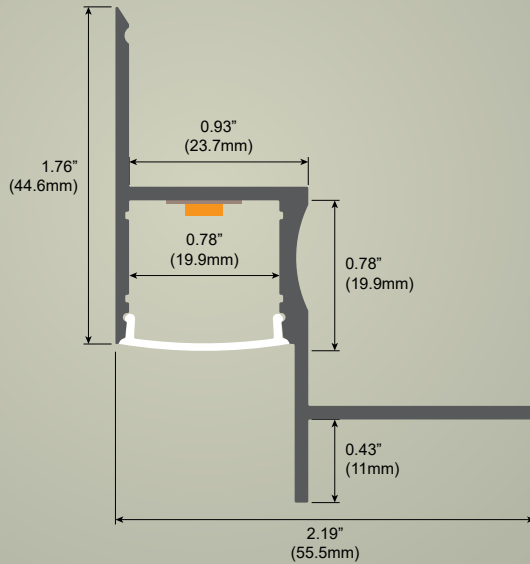

## LS-AT7N Suitable for PCB 18mm

- Max. LED power : 5.9w/ft (19.2w/m)
- Installation : Wall / Ceiling Recessed
- Material : Extruded Aluminium 6063
- Finish : Silver anodised, Black or White
- Diffuser : PMMA flexible diffuser
- Length : 78.75"(2000mm) or 98.5"(2500mm) continuous
- Size : Profile w2.19"(55.5mm) x h1.76"(44.6mm)
- Driver installation : Remote driver required

Custom powder coated colour upon request. Surcharge apply.

Profile sold per metre.

Can be cut to suit any length up to 19' - 8"(6000mm).



### PMMA Diffuser

CODE: AT7N-O (OPAL, LIGHT TRANS. >52%)  
 CODE: AT7N-F (FROST, LIGHT TRANS. >81%)  
 CODE: AT7N-C (CLEAR, LIGHT TRANS. >95%)

### PC Diffuser

CODE: AT7N-O (OPAL, LIGHT TRANS. >50%)



## Installing accessories



### AT7N

#### Plastic Endcap

CODE: AT7N-CAP  
 CODE: AT7N-CAP-H



**NESLight**  
CUSTOM LED SOLUTIONS  
[WWW.NESLIGHT.COM](http://WWW.NESLIGHT.COM)

**Headquarters**

1179 Edgewater Ave. Ridgefield, NJ 07657  
Tel : 201-840-0400

E-mail : [neslight@gmail.com](mailto:neslight@gmail.com)  
[info@neslight.com](mailto:info@neslight.com)  
[sales@neslight.com](mailto:sales@neslight.com)