



2021

Track Light

www.neslight.com

NES Light
SMART SOLUTION

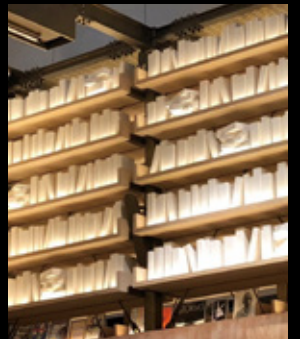

Track Light

CONTENTS

- P3. Track Linear
- P4. Track Linear-Asymmetric
- P5. Track Spot
- P6. Installation & Accessory
- P7. Application

Special design for Display, Cabinet and Furniture lighting.
Easy for installation and replacement.

Track Linear

Available Color : 2,500K / 2,700K / 3,000K / 3,500K / 4,000K / 6,000K

Operating Temperature : 0~45°C / 32~113°F

Color Rendering : Ra > 80, > 90

Luminous Flux : 50~70 lm/W

Voltage input : DC 24V

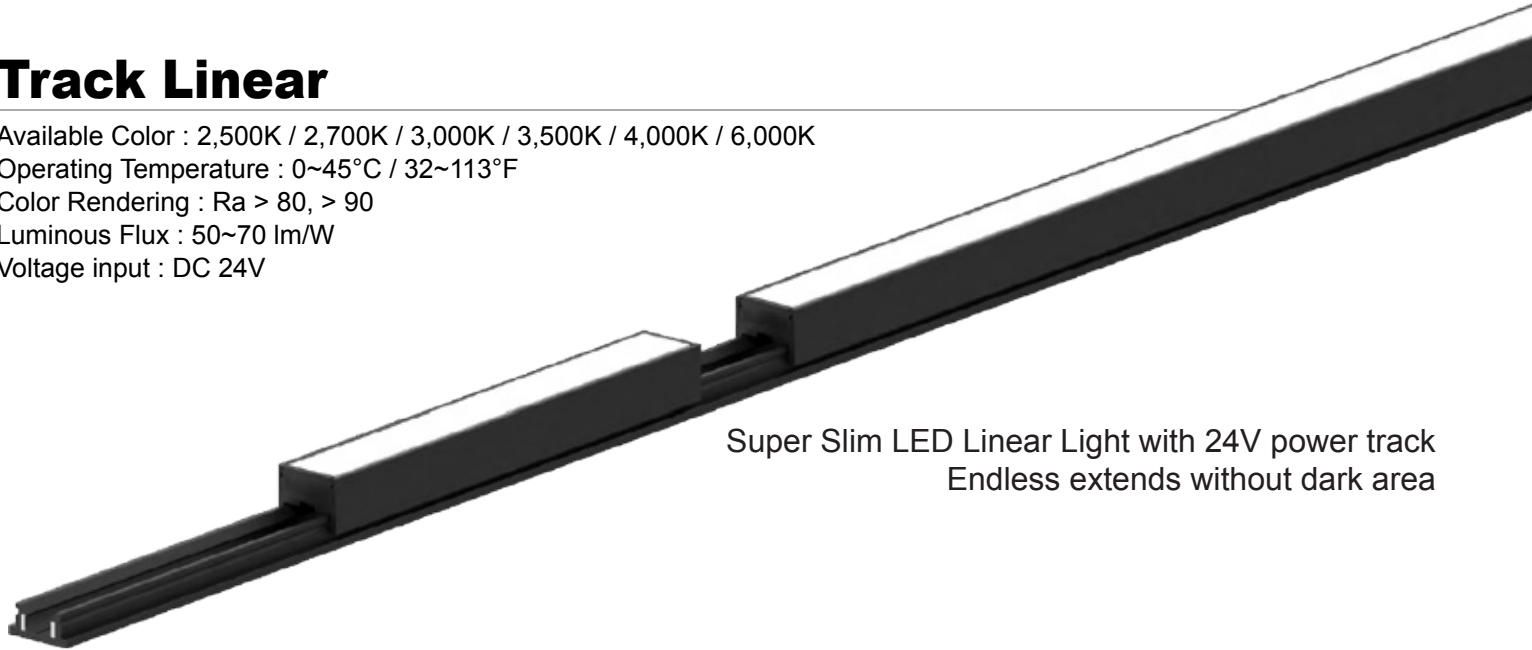

Super Slim LED Linear Light with 24V power track
Endless extends without dark area

Track Linear

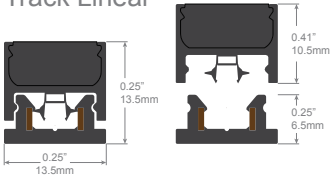

Aluminium Housing

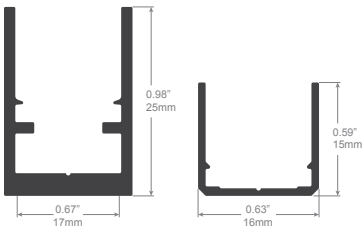

PICTURE	MODEL	DIMENSIONS	MAX POWER	LUMINOUS FLUX	LIGHT DISTRIBUTION CURVE
	TP01-100	3.93" (100mm)	1.5W	50-70lm/W	
	TP01-200	7.87" (200mm)	3W	50-70lm/W	
	TP01-300	11.8" (300mm)	4.5W	50-70lm/W	
	TP01-500	19.68" (500mm)	7.5W	50-70lm/W	

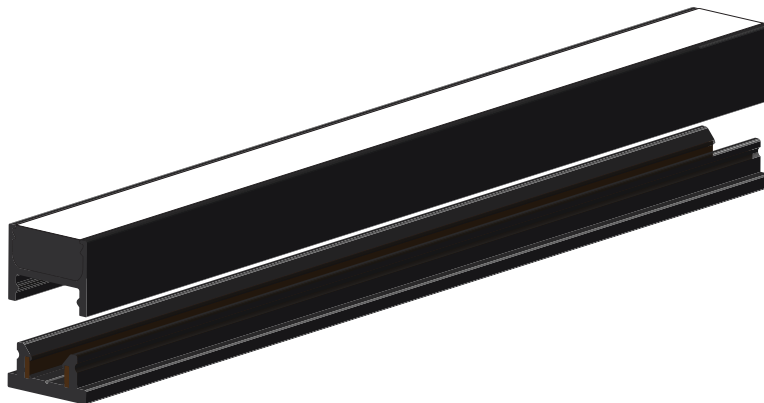

Track Linear Asymmetric

Available Color : 2,500K / 2,700K / 3,000K / 3,500K / 4,000K / 6,000K

Operating Temperature : 0~45°C / 32~113°F

Color Rendering : Ra > 80, > 90

Luminous Flux : 50~70 lm/W

Voltage input : DC 24V





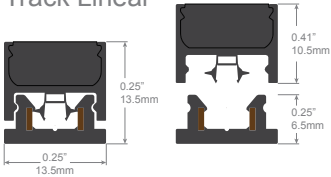

Track Linear

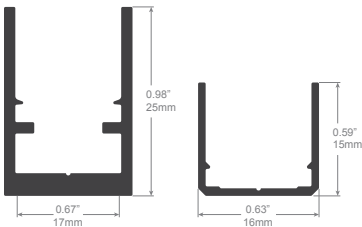

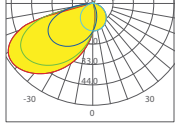
Aluminium Housing

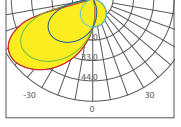

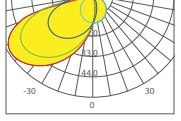
PICTURE	MODEL	DIMENSIONS	MAX POWER	LUMINOUS FLUX	LIGHT DISTRIBUTION CURVE
	TP01A-200	7.87" (200mm)	3W	50-70lm/W	
	TP01A-300	11.8" (300mm)	4.5W	50-70lm/W	
	TP01A-500	19.68" (500mm)	7.5W	50-70lm/W	

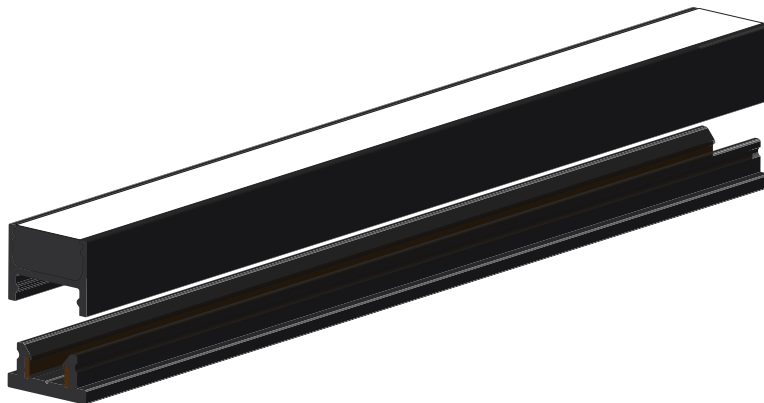

Track Spot

Available Color : 2,500K / 2,700K / 3,000K / 3,500K / 4,000K / 6,000K
 Beam Angle : 15°, 30°, 50°
 Voltage input : DC24V
 Lamp Power : 1.5W
 Luminous Flux : 50-60 lm/W
 Color Rendering : Ra > 80, >90
 Operating Temperature : 0~45°C(32~113°F)

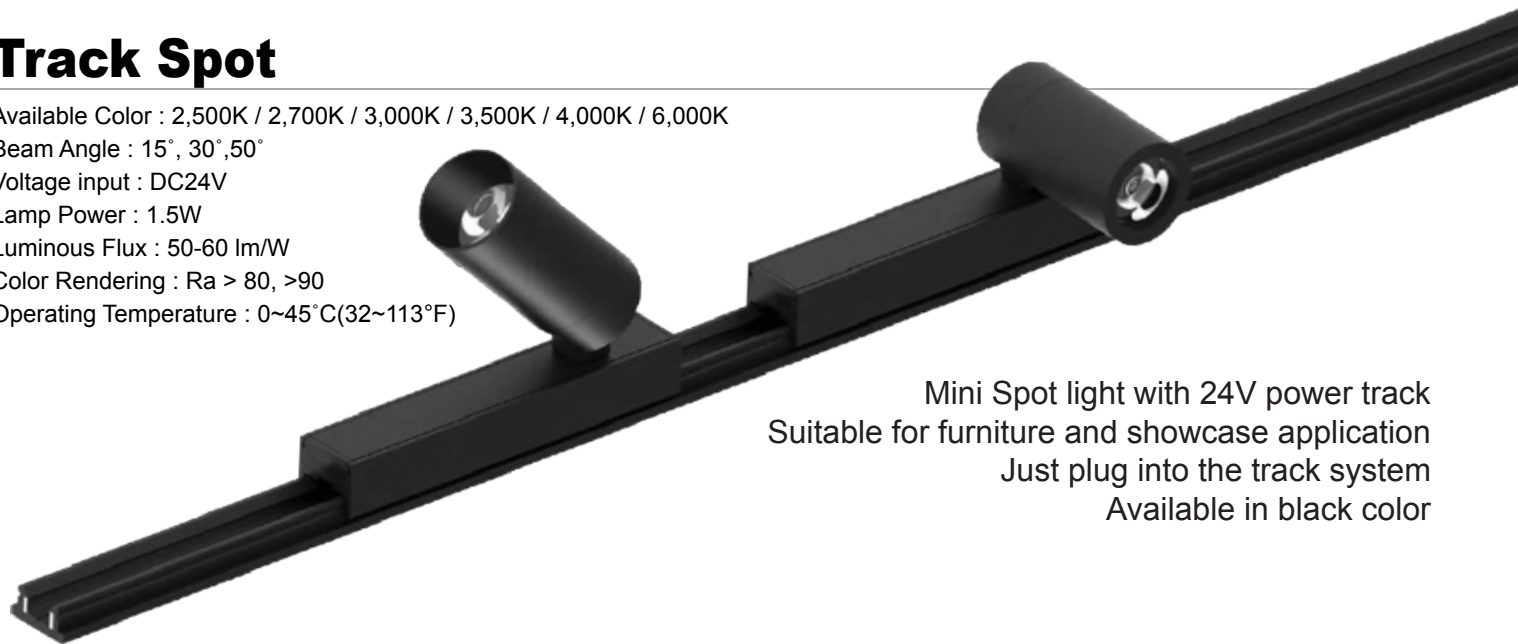

Mini Spot light with 24V power track
 Suitable for furniture and showcase application
 Just plug into the track system
 Available in black color

Track Spot

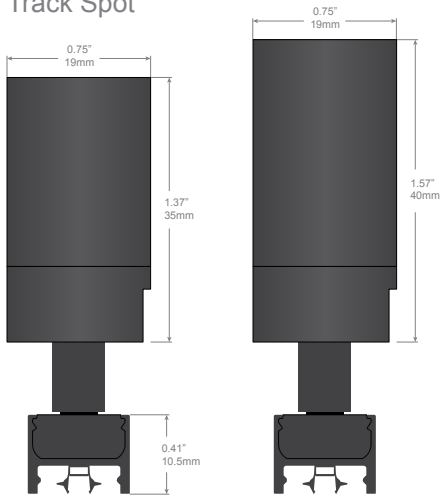

PICTURE	MODEL	MAX POWER	LUMINOUS FLUX	LIGHT DISTRIBUTION CURVE
	TP02 - 15	1.5W	50-60lm/W	
	TP02 - 30	1.5W	50-60lm/W	
	TP02 - 50	1.5W	50-60lm/W	

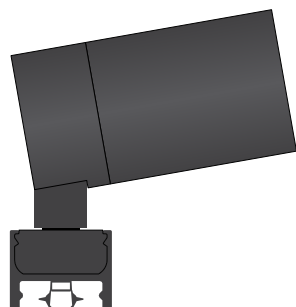
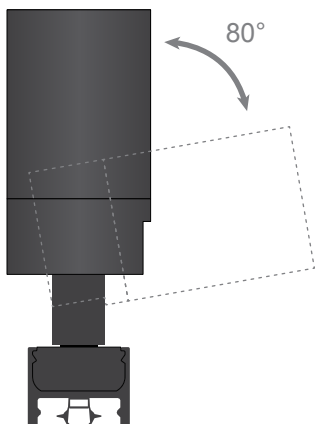

Aluminium Housing

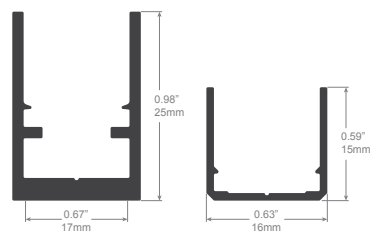

Installation Option 1

Fixing without screw, only suit for wood application

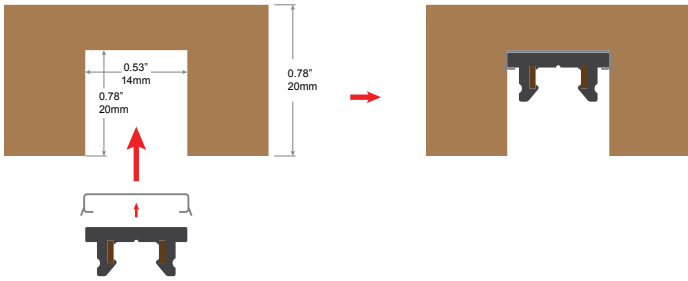

Installation Option 2

Fixing with screw

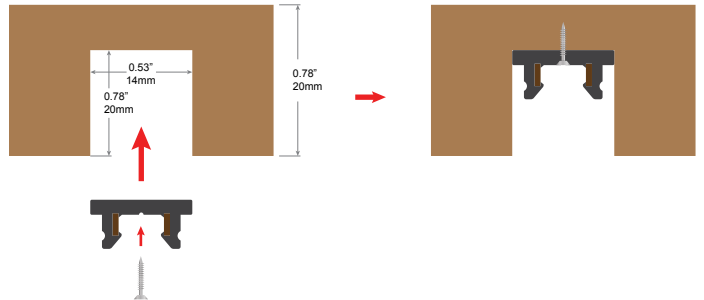

Final Connect Assembly



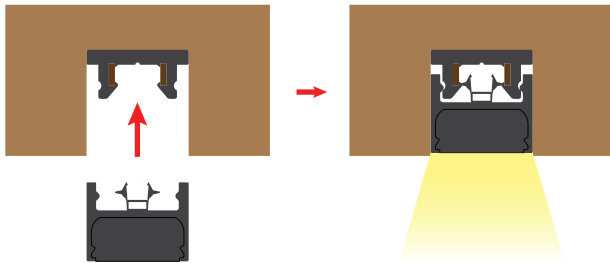

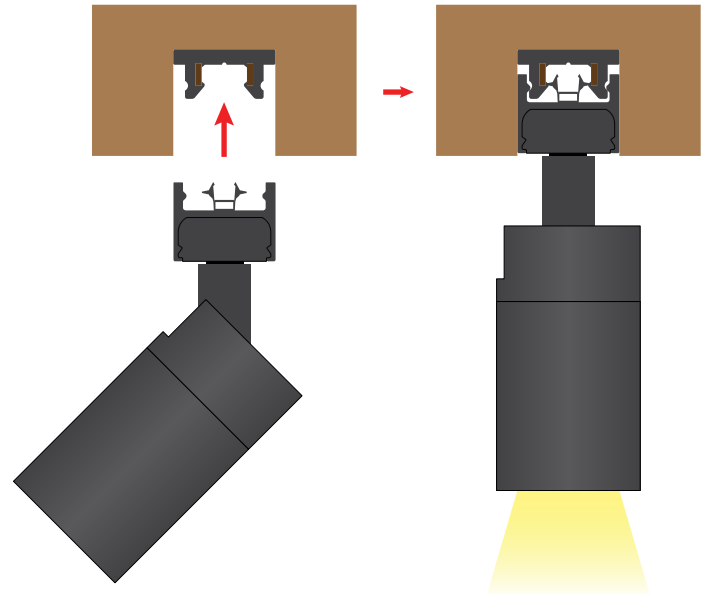

Track Linear









Track spot



Accessory & Power supply

ITEM	MODEL #.	DETAILS
	TPR01	Track Rail
	TPR01 AL1	Track Rail with Aluminium Housing
	TPR01 AL2	Track Rail with Aluminium Housing
	TPP01	24v Power Connector
	TPC01	24v Power Connector
	BODY	Sensor Switch

ITEM	MODEL #.	DETAILS
	MICROWAVE	Sensor Switch
	INFRARED	Switch
	SLT30	24V 30W
	SLT60	24V 60W
	SLT100	24V 100W
	SLT150	24V 150W

Front Side Track Spot



Inside Track Linear



Front Side Track Linear



Middle Side Track Linear



•••
NES Light
SMART SOLUTION

1179 Edgewater Ave. Ridgefield, NJ 07657 / Tel : (201) 840-0400 / neslight@gmail.com / info@neslight.com

